



Section 2 NORTH AMERICAN CYLINDER

Key Blanks designed for locks used primarily in the North American Market.
The lock manufacturers are listed in alphabetical order where possible.

There are several symbols and suffixes used in this section. Below is a legend of their use.



Special Key Machine Required

Color Plastic Head Key

-PC

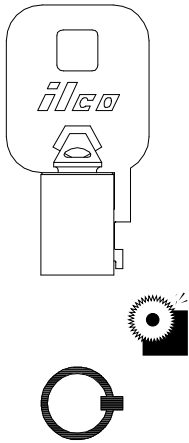
ACE
ACORN
ADAMS RITE

OD .377" - 9.6mm
ID .312" - 7.9mm
(BRASS)

1137B

—

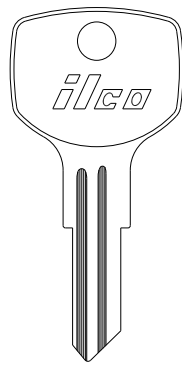

A54B

—

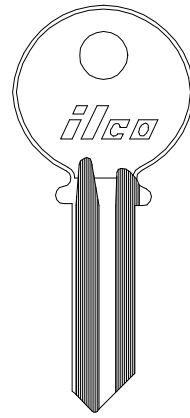

999

Y1

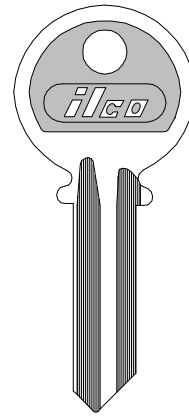

Y1-PC

—

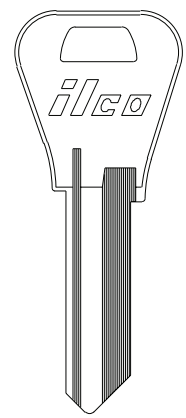

1054WB

WR3

ILCO
EZ

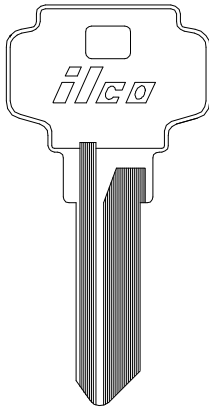
ADAMS RITE
ALMET

D1054K

DE6

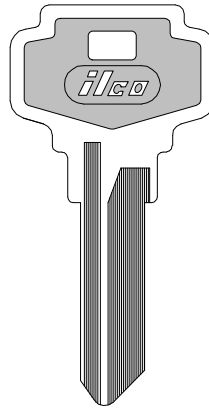

DE6-PC

—

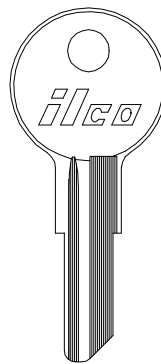

L1054B

IN8

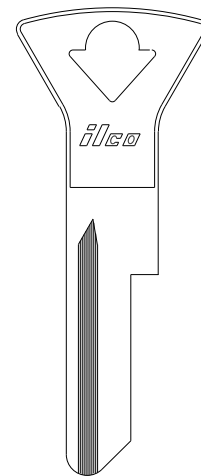

K1145

—

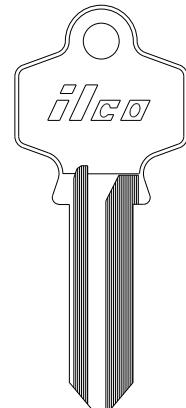

AE1

—

ILCO
EZ

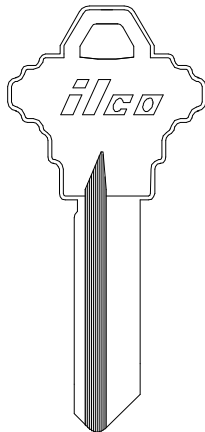
ALMET

1145A

SC4

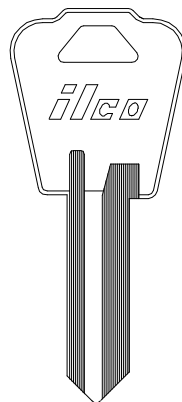

1177N

NH1

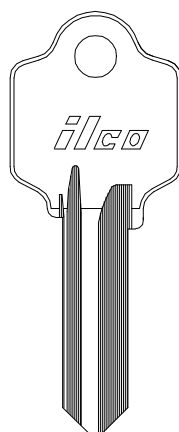

1179

AR1

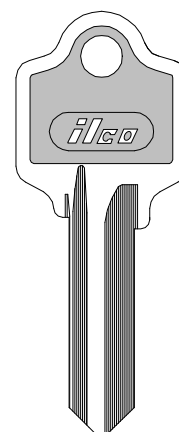

AR1-PC

—

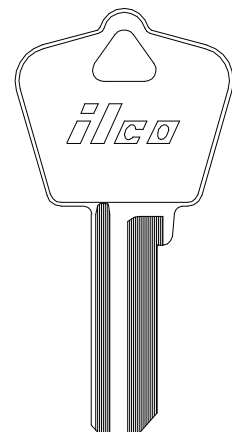

N1179

—

ILCO
EZ

ALMET	AMERICAN LOCK			
1179A AR4	1041B —	1041C AM1	1041CK —	5 PIN 1045 AM3
				6 PIN A1045 —

ILCO
EZ

AMERICAN LOCK	AMEROCK			
6 PIN A1041U	5 PIN 1046	6 PIN 1046A	1653 AM4	AK22W —
				R1064E NA25
				NA25-PC —

ILCO
EZ

ARCO	ARFE			
1130 —	1130R —	1131 —	1131R —	1635J —
				1635K —
				1635L —
				1635V —

ILCO
EZ

ARROW

5 PIN 6 PIN	6 PIN				
ILCO EZ DT22W	DTL22W	755U	1179 AR1	AR1-PC	N1179
—	—	—	—	—	—

ARROW

ILCO EZ 1179A AR4	N1179A	A1179E	A1179J	A1179P	A1179U	
—	—	—	—	—	—	—

ARROW
AUTH FLORENCE BALDWIN

					5 PIN 6 PIN	
ILCO EZ B1179-1C	B1179-1D	CH1C	CH1D	1652 AF1	1510 BW2	1511
—	—	—	—	—	—	—

BARGMAN

BARROWS

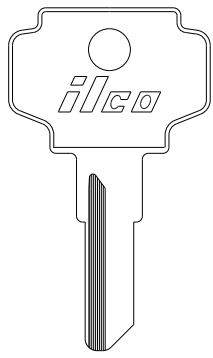

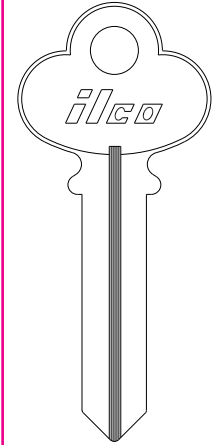
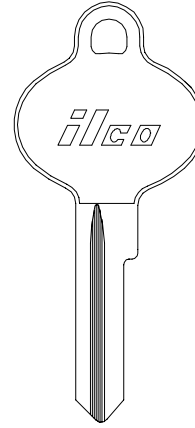
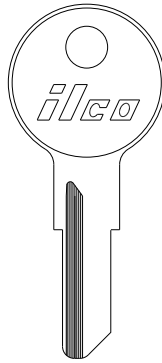

K1054B
IN24



K1122B
—

K1122C
—

L1054M
—

K1122N
—

L1098M
—

K1122D
BN1



1761B
—

1021A
—

ILCO
EZ

BARROWS

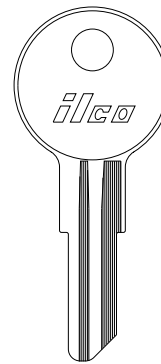
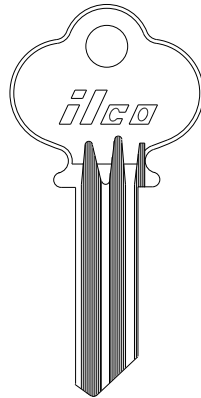
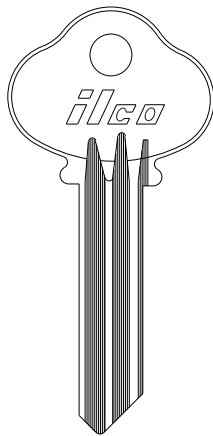
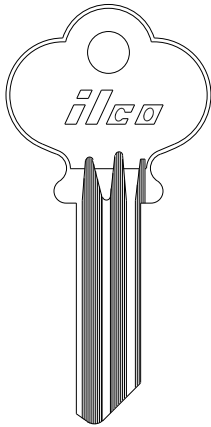
BAUER



1021B
—

1021BA
—

1021N
—



1618
BAU1

1618R
BAU1R

ILCO
EZ

BAUER

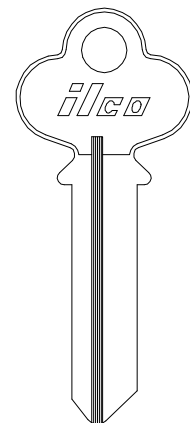
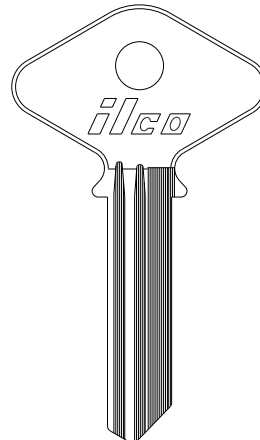
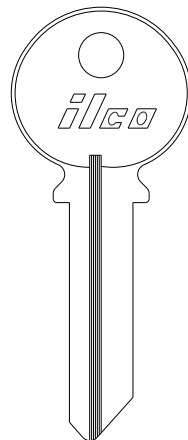
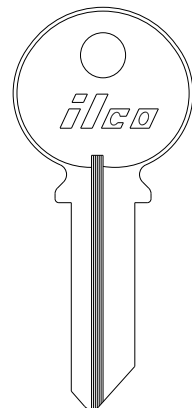
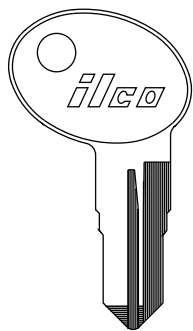
BELLEVILLE



1648
BAU2



1036
—

1036A
—

1036G
—

1036S
—

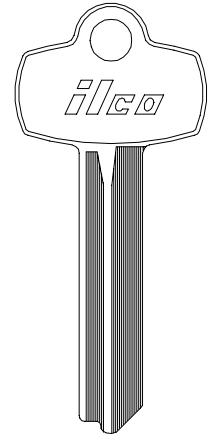
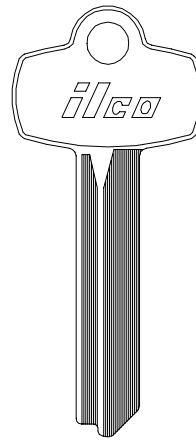
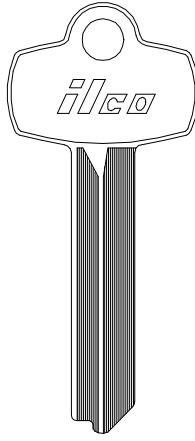
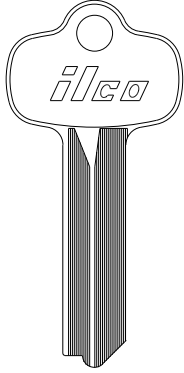
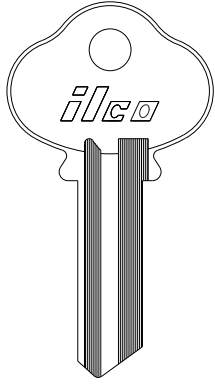
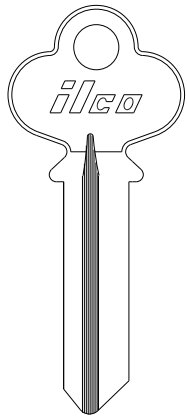
ILCO
EZ

BELLEVILLE
BEST

ILCO
EZ

1036SF
—

1036U
—

1114
—

A1114A
BE2

A1114B
—

A1114C
—

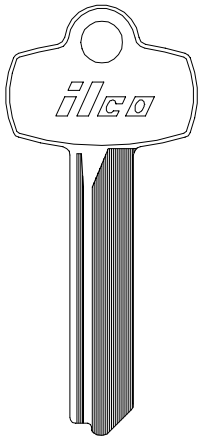
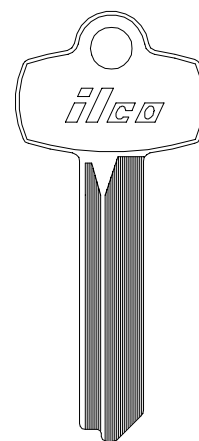
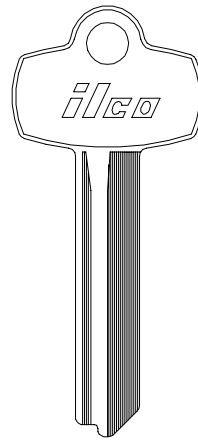
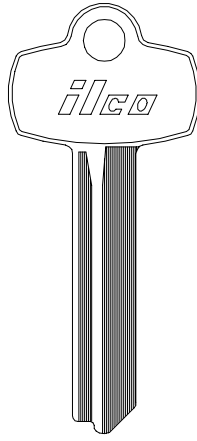
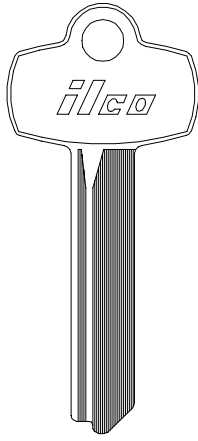
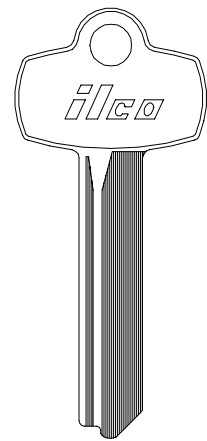
BEST

ILCO
EZ

A1114D
—

A1114DD
—

A1114E
—

A1114F
—

A1114FM
—

A1114G
—

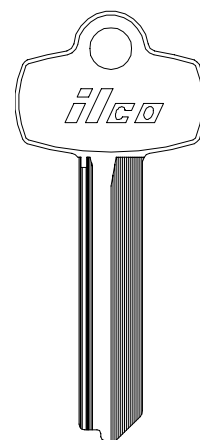
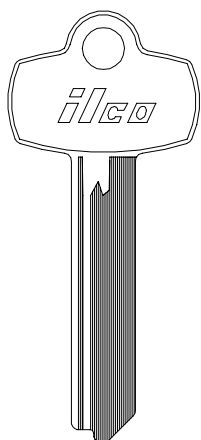
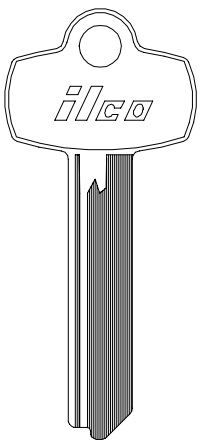
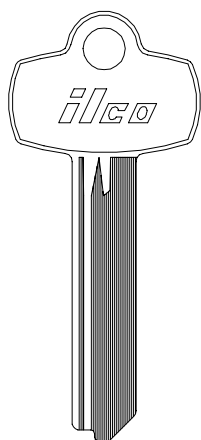
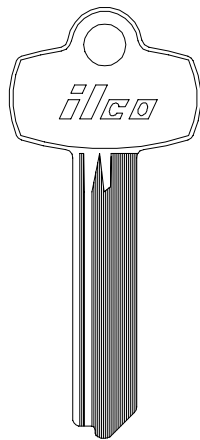
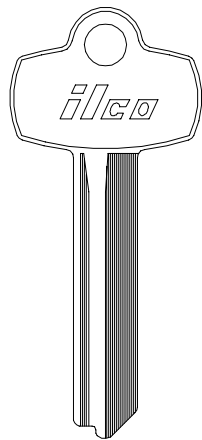
BEST

ILCO
EZ

A1114H
—

A1114J
—

A1114K
—

A1114L
—

A1114M
—

A1114Q
—

BEST - CHALLENGER



NORTH AMERICAN CYLINDER

sec 2 page 6

BEST		BOMMER			CAM LOCK	CANADIAN BLDR.
A1114R	A1114TB	1003M	R1003M	1069LC	1631	25
—	—	CO106	BO1	NA24	—	—

ILCO
EZ

CANADA POST

P54F	752	1558	1594	1632	LF25
—	—	—	—	—	—









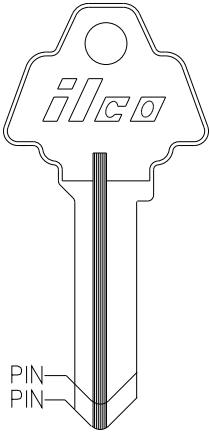
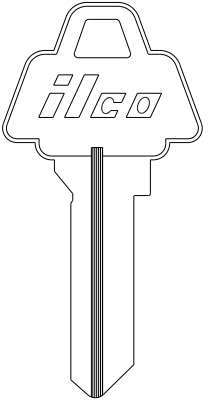
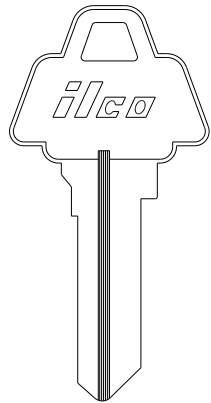

ILCO
EZ

CANADA POST CEMEX CHALLENGER

1659	1659R	1661	1548	1549	1550	1170
—	—	—	—	—	—	—

ILCO
EZ





CHALLENGER

					
		A1170C		1170BD	
	—	—	—	—	—
					
	A1170CB		1170CJ		
	—	—	—	—	—
					
	A1170D		1170E		
	—	—	—	—	—
					
ILCO	1170B	A1170B	1170C	1170D	1170M
EZ	HO1	HO4	—	—	—

CHALLENGER
CHANTRELL
CHESSLER
CHICAGO

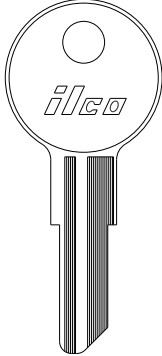
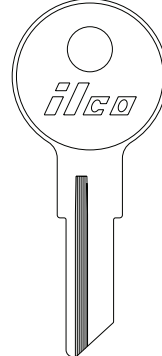
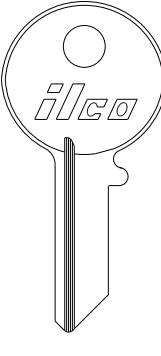
	SEE LOCKWOOD			
L1170		1178	100AM AP5	1041E CG22
—		—		

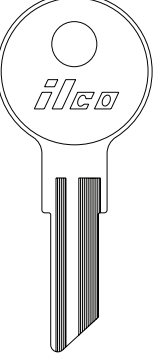
CHICAGO

						
1041T	1041TR	1041X	1041Y	C1041A	C1041C	C1041B
CG16	—	—	CG17	—	—	—

 NORTH AMERICAN
CYLINDER

CHICAGO

C1041L	—	C1041N	—	C1041J	H1041T	S1041JA	S1041T	1041FM	
			—						
	C1041P		—						
	—								

NORTH AMERICAN CYLINDER

ILCO
EZ

sec 2 page 8

CHICAGO

	4 PIN		5 PIN		4 PIN		5 PIN		
	SC1041R	C1041R	SC1041TR	C1041TR					
	—	—	—	—					
	SC1041S	C1041JB	SC1041YR	C1041YR					
	—	—	—	—					
		SC1041SR	C1041SR						
	—	—	—						
		SC1041T	C1041T						
	—	—	—						

ILCO
EZ

CHICAGO

OD .365" - 9.3mm ID .300" - 7.6mm (STEEL)	OD .377" - 9.6mm ID .312" - 7.9mm (BRASS)	OD .X377" - 9.6mm ID .312" - 7.9mm (STEEL)	OD .399" - 10.1mm ID .329" - 8.4mm (STEEL)	
1136S	1137B	1137S	L1137	41FD
—	—	—	—	—

ILCO
EZ

CHICAGO

CLUB CAR

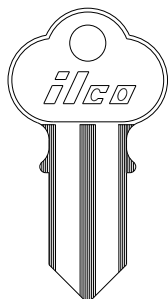

CC29
—

CC30
—

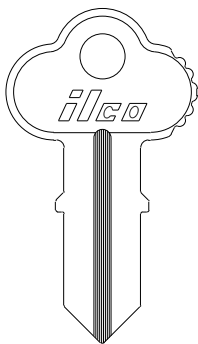

1041DB
—

1041DC
—

1041DH
—

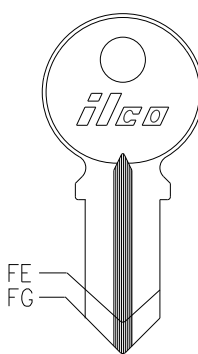

FE
FG

1041FE **1041FG**
— —

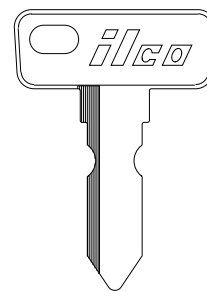

CC1
—

CC21
—

1041D
—

ILCO
EZ

CHICAGO

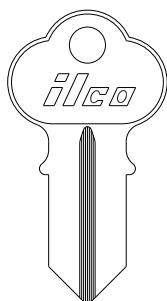

1041GA **1041N**
CG2 —

1041GB
—

1041GR
—

1041G
CG1

1041K
—

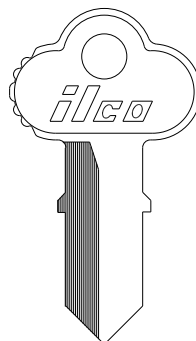

1041DE
—

R1041DC
—

1041DV
—

R1041DV
—

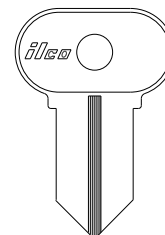

1041M
—

ILCO
EZ

CHICAGO

CHUCKAMKEE

CLINTON

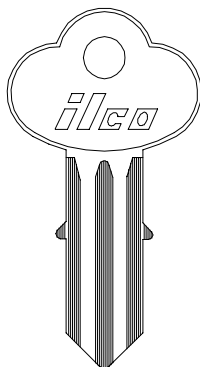

C1041DN
—

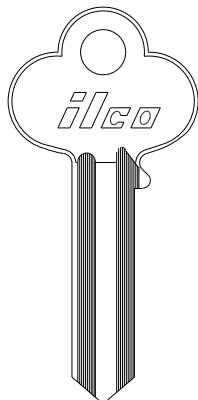

62CKK
—

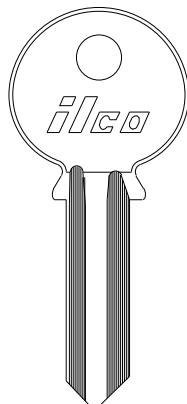

67CL
—

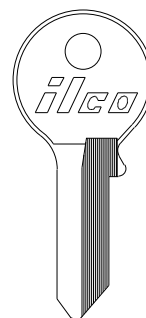

L67A
—



L67B
—

ILCO
EZ

CLINTON

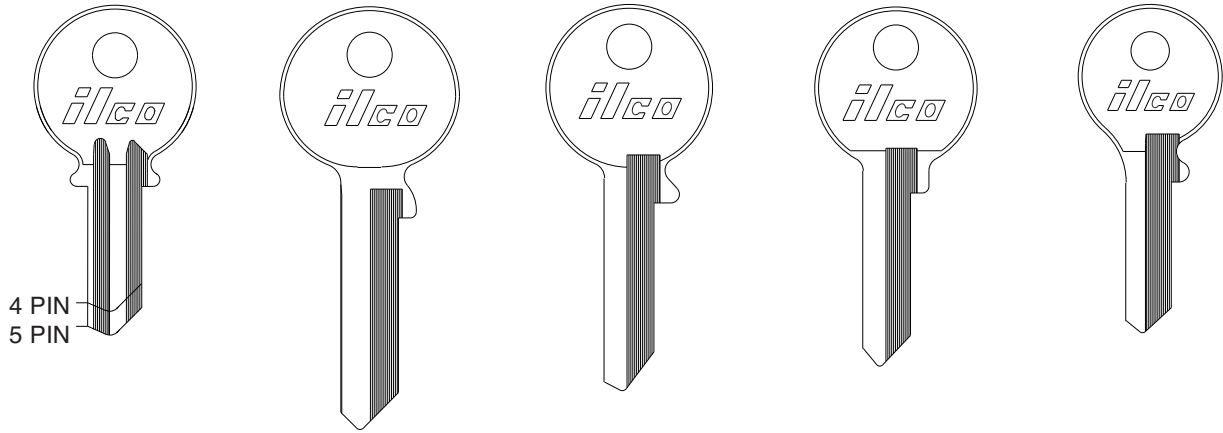

4 PIN
5 PIN

4 PIN 5 PIN
S67B 1067B

T67A

T67B

T67C

T67D

ILCO
EZ

CLINTON

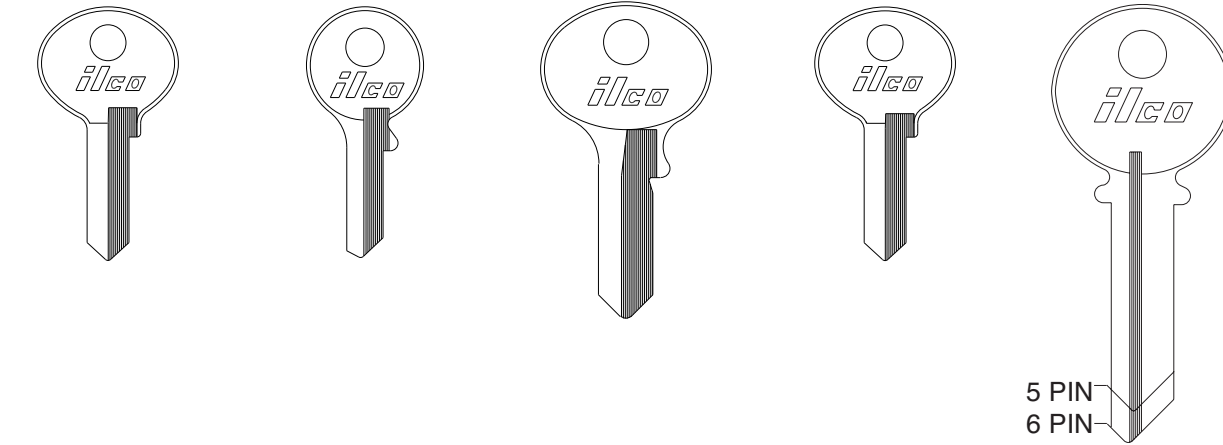

5 PIN
6 PIN

T67E

T67F

C92

C92B

5 PIN 6 PIN
1023 1023A
CL1 —

ILCO
EZ

CCL (formerly Corbin Cabinet Lock)

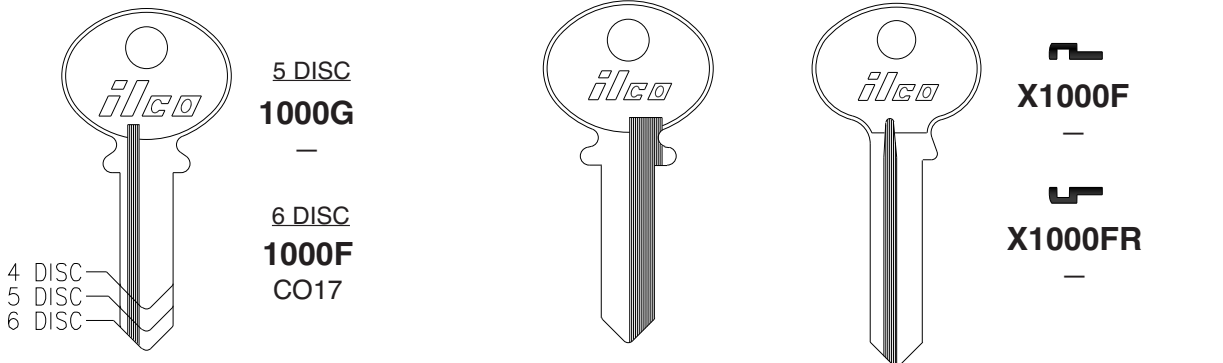

4 DISC
5 DISC
6 DISC

5 DISC
1000G

6 DISC
1000F
CO17

X1000F

X1000FR

4 DISC
1000H

1000FR

1000FX

ILCO
EZ

CCL - (formerly Corbin Cabinet Lock)

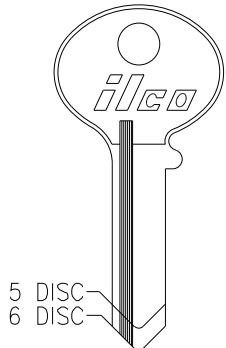
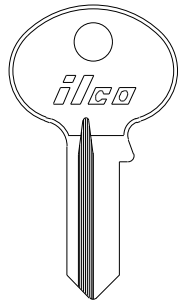
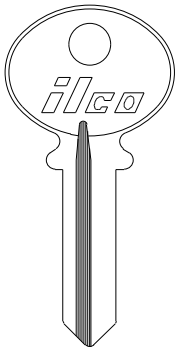
	5 DISC	6 DISC			
	X1000GR	SX1000FR			XO1000F
	-	-			
	-	-			
	XO1000GR	XO1000FR			
	-	-			
<p>ILCO EZ</p>	5 DISC	6 DISC	O1000H	O1000GX	O1000GR
	X1000G	SX1000F	-	-	-
	CO10	-	-	-	-



NORTH AMERICAN
CYLINDER

sec 2 page 11

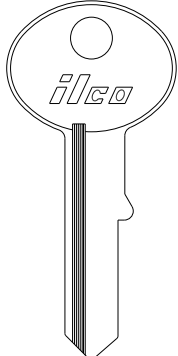
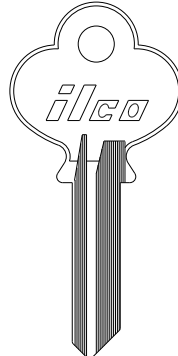
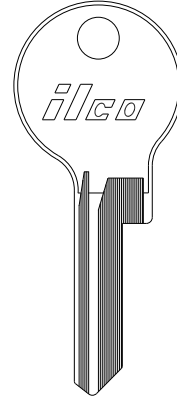
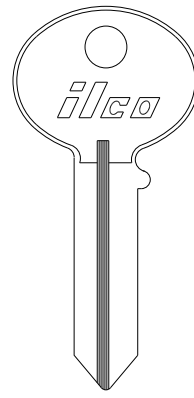
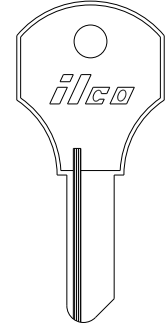
CCL (formerly Corbin Cabinet Lock)

<p>ILCO EZ</p>						
						1000HL
	-	-	-	CO9	-	-

CCL (formerly Corbin Cabinet Lock)

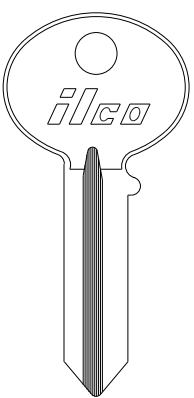
	5 DISC	6 DISC	5 DISC	6 DISC			
	SR1000T	R1000T	S1000X	1000X			
	-	-	-	CO63			
	S1000V	1000V	S1000XK	1000XK			
	CO68	CO26	-	-			
	SR1000V	R1000V					
	-	-					
<p>ILCO EZ</p>	5 DISC	6 DISC	S1001JB	1000P	1001CR	1001D	R1001D
	S1000T	1000T	-	-	-	-	-
	-	CO12					

CCL (formerly Corbin Cabinet Lock)

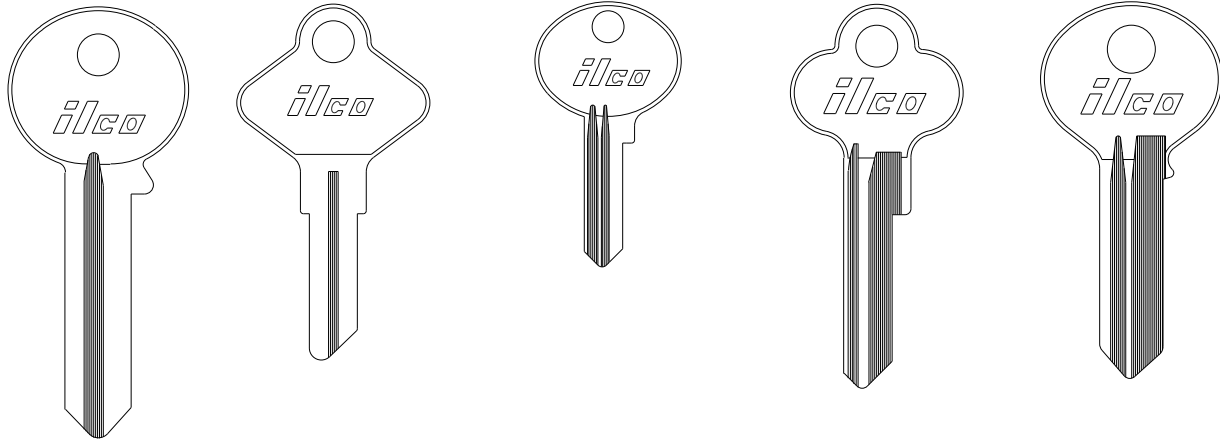

1001DA 1001JL 1000JR 1001K X1001KC 1001WL

— — — — — —

ILCO
EZ

NORTH AMERICAN
CYLINDER

sec 2 page 12

CCL (formerly Corbin Cabinet Lock)

4 PIN	S1003A —	S1003B —	S1003C —	S1003D —
5 PIN	1003A —	1003B —	1003C —	1003D —
6 PIN	L1003A —	L1003B —	L1003C —	L1003D —

4 PIN	S1003AB —	S1003CD —
5 PIN	1003AB —	1003CD —
6 PIN	L1003AB —	L1003CD —

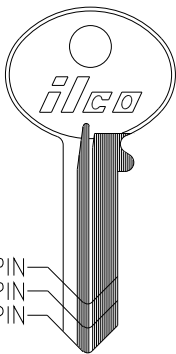









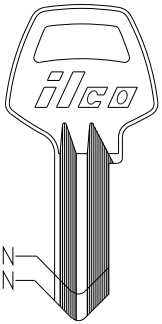
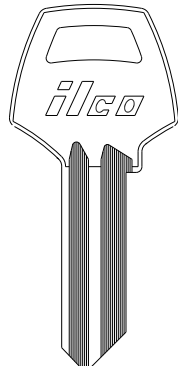
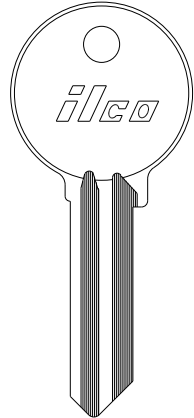
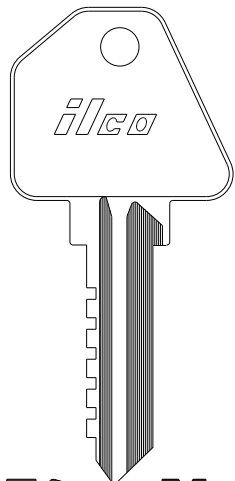
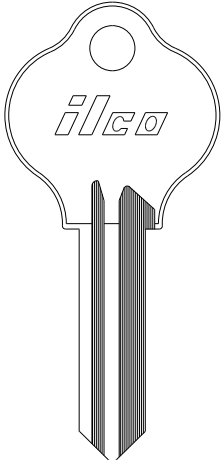

4 PIN
5 PIN
6 PIN

4 PIN	S1003M —
5 PIN	1003M CO106
6 PIN	L1003M —

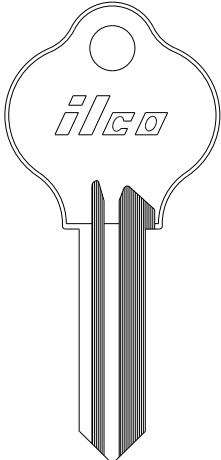
ILCO
EZ

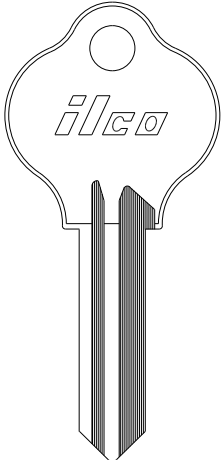
CORBIN (now Corbin / Russwin)







				
3 PIN 4 PIN				
				
3 PIN CB1	4 PIN CB2	CB3	CB7	CB9
—	—	—	—	—
				
				
CB10				
—				
				
				
CB11				
—				

ILCO
EZ

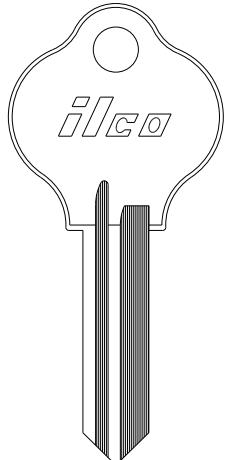
**NORTH AMERICAN
CYLINDER**

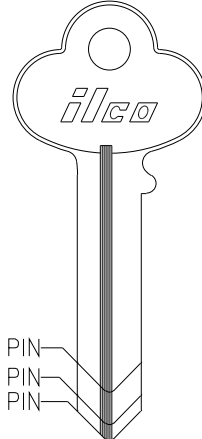
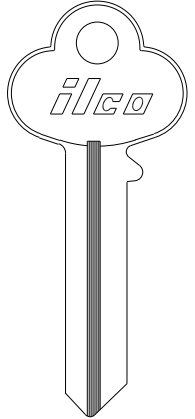









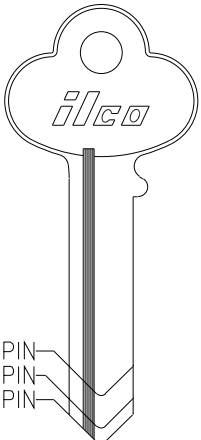
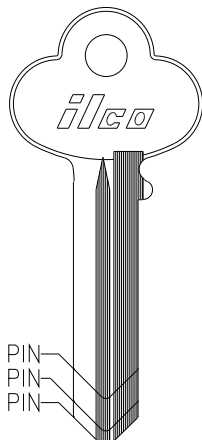









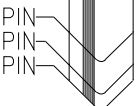
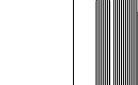







sec 2 page 13

CORBIN (now Corbin / Russwin)

			
		5 PIN 6 PIN 7 PIN	6 PIN 7 PIN
			
CB11BH	CB12	5 PIN 1000 CO1	1000AB
—	—	—	—

ILCO
EZ

CORBIN (now Corbin / Russwin)

					
5 PIN 6 PIN 7 PIN	5 PIN 6 PIN 7 PIN	5 PIN	6 PIN	6 PIN	7 PIN
					
5 PIN 1001EA (MASTER)	7 PIN 1001E (MASTER)	R1001EF	1001MC	R1001EE CO35	1001EJ
—	—	—	—	—	—
					
5 PIN	5 PIN 6 PIN 7 PIN	6 PIN	6 PIN	6 PIN	7 PIN
					
5 PIN 1001EB CO3	R1001CEM (MASTER)	1001MA	1001MG	R1001EK	A1001MA
—	—	—	—	—	—
					
5 PIN	6 PIN	6 PIN	6 PIN		
					
1001MB	R1001ED	R1001EM (MASTER)	A1001MF		
—	—	—	—		

ILCO
EZ

CORBIN (Now Corbin/Ruswin)

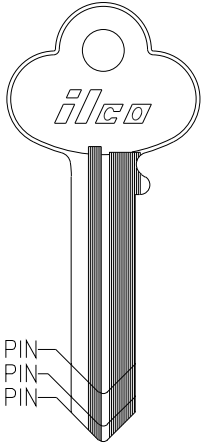

5 PIN
6 PIN
7 PIN

5 PIN
 6 PIN

1001MJ A1001MJ
— —

1001EN 1001EG
(MASTER) (MASTER)
CO7 CO36

1001ES B1001EJ
(MASTER) (MASTER)
— —

6 PIN

A1001HP 1001EL
(MASTER) (MASTER)
— —

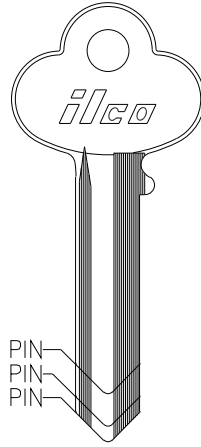

5 PIN
6 PIN
7 PIN

5 PIN
 6 PIN

R1001MJ R1001EG
(MASTER) (MASTER)
— CO62

R1001EN R1001ET
(MASTER) (MASTER)
SK1 —

R1001ES R1001EL
(MASTER) (MASTER)
— —

6 PIN

A1001MJR
—

NORTH AMERICAN
CYLINDER

ILCO
EZ

CORBIN (now Corbin / Russwin)

ILCO
EZ

5 PIN	1001AH —	1001FH —	1001BH —	1001DH —	1001C1 —	1001C2 —	1001D1 —
6 PIN	A1001AH CO91	A1001FH CO92	A1001BH CO94	A1001DH CO95	A1001C1 CO98	A1001C2 CO102	A1001D1 CO107
7 PIN	L1001AH —	L1001FH —	L1001BH —	L1001DH —	L1001C1 —	L1001C2 —	L1001D1 —

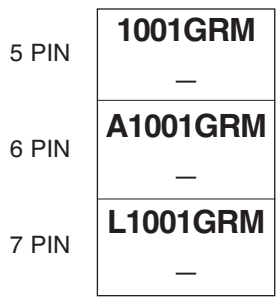
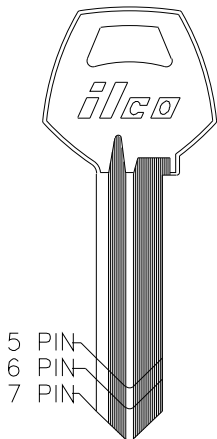
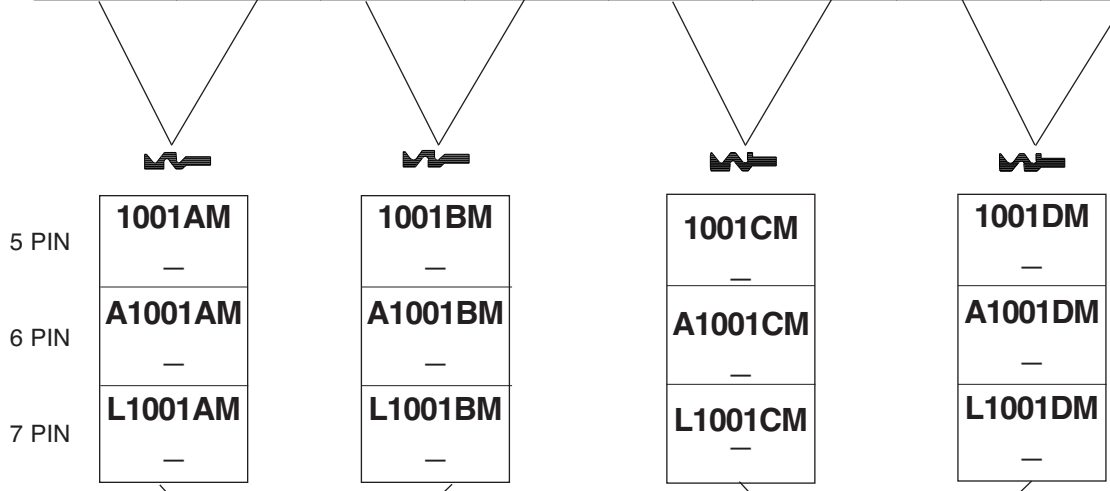

NORTH AMERICAN
CYLINDER

CORBIN (Corbin / Russwin)

NORTH AMERICAN
CYLINDER

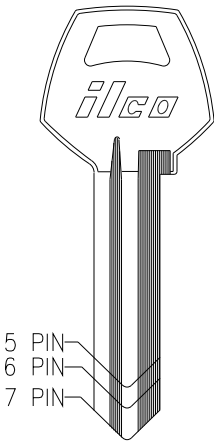

6 PIN
A1001EH
CO88

7 PIN
L1001EH
—

5 PIN
1001EH
CO87

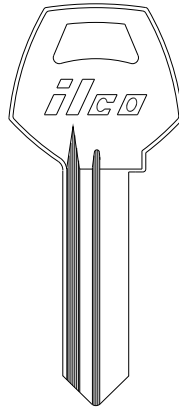

A1001EHR
—

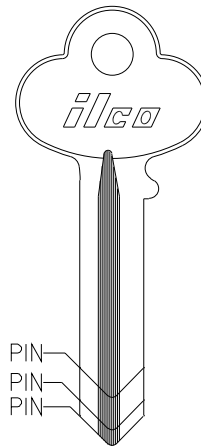

6 PIN
1001AB
C06

7 PIN
1001A
—

1001
CO5

ILCO
EZ

CORBIN (now Corbin / Russwin)

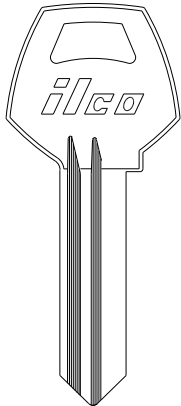

1001A1 **1001A2**
— —

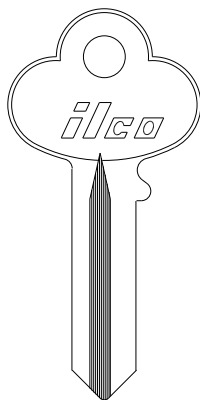

1001C
—

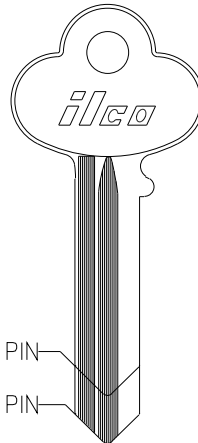

1001GB
—

7 PIN

1001GA
—

R1001GA
—

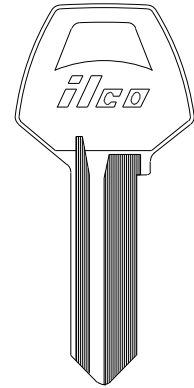

1001GH
CO97

ILCO
EZ

CORBIN (now Corbin / Russwin)

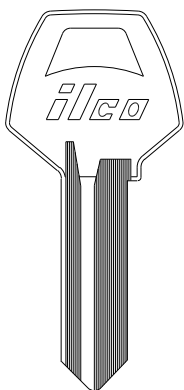

1001MK
—

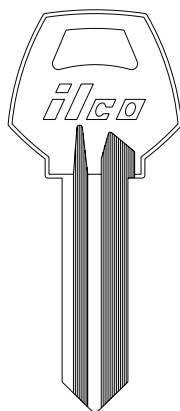

O1001E
—

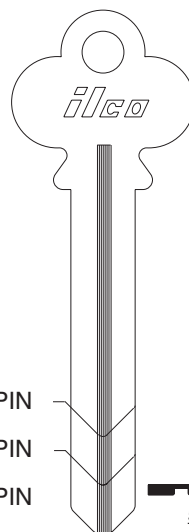

6 PIN
1002A
—

7 PIN
1002
—

5 PIN
1002B
—

ILCO
EZ

ILCO
EZ

NORTH AMERICAN
CYLINDER

5 PIN	1011-L1 —	1011-L2 —	1011-L3 —	1011-L4 —
6 PIN	A1011-L1 —	A1011-L2 —	A1011-L3 —	A1011-L4 RU101
7 PIN	L1011-L1 —	L1011-L2 —	L1011-L3 —	L1011-L4 —

5 PIN	1011-L12 —	1011-L34 —
6 PIN	A1011-L12 —	A1011-L34 —
7 PIN	L1011-L12 —	L1011-L34 —

5 PIN	1011-L41 —
6 PIN	A1011-L41 —
7 PIN	L1011-L41 —

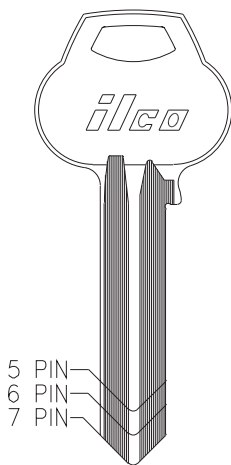

CORBIN / RUSSWIN

NORTH AMERICAN
CYLINDER

sec 2 page 18

5 PIN	1012-D1 —	1012-D2 —	1012-D3 —	1012-D4 —
6 PIN	A1012-D1 —	A1012-D2 —	A1012-D3 —	A1012-D4 —
7 PIN	L1012-D1 —	L1012-D2 —	L1012-D3 —	L1012-D4 —

5 PIN	1012-D12 —	1012-D34 —
6 PIN	A1012-D12 —	A1012-D34 —
7 PIN	L1012-D12 —	L1012-D34 —

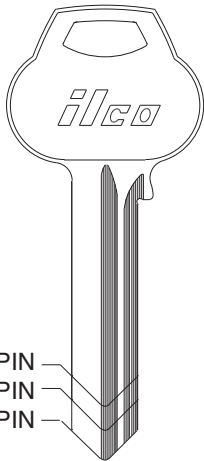

5 PIN
6 PIN
7 PIN

5 PIN	1012-D41 —
6 PIN	A1012-D41 —
7 PIN	L1012-D41 —

ILCO
EZ

CORBIN / RUSSWIN

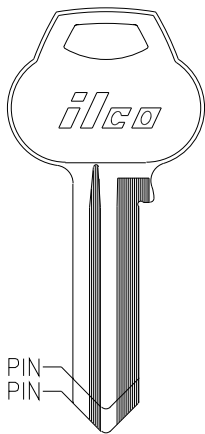

5 PIN
6 PIN

6 PIN
A1012-60
—

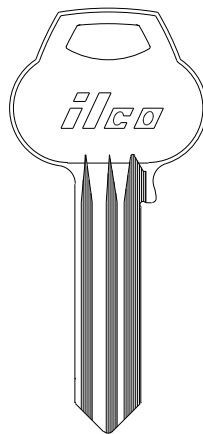

5 PIN
1012-60
—

A1012-H1 A1012-H6
— —

A1012-H2 A1012-H7
— —

A1012-H3 A1012-H8
— —

A1012-H5
—

ILCO
EZ

CORBIN / RUSSWIN

A1012-59A1	A1012-59A2 CR92	A1012-59B1 CR94	A1012-59B2 CR95	A1012-59C1	A1012-59C2	A1012-59D1	A1012-59D2
—	—	—	—	—	—	—	—



A1012-59A
—

A1012-59B
—

A1012-59C
—

A1012-59D
—



A1012-59AB
—

A1012-59CD
—



A1012-59AD
—

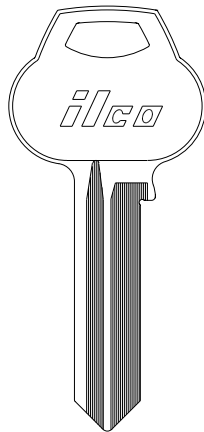

ILCO
EZ

NORTH AMERICAN
CYLINDER

sec 2 page 19

CORBIN / RUSSWIN

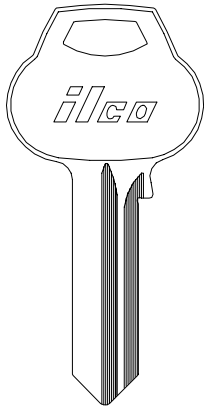

CR45

—

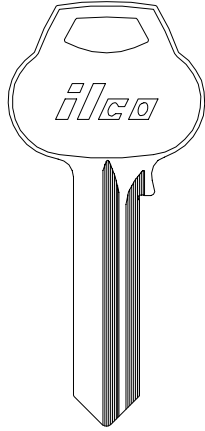

CR46

—

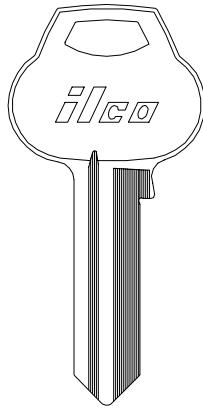

CR87

—

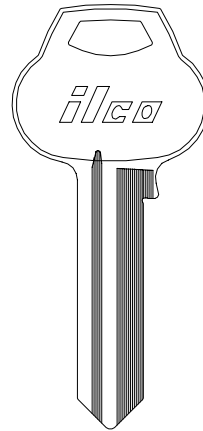

CR88

—

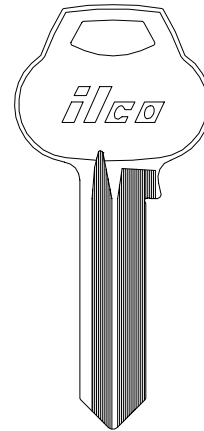

CR89

—

ILCO
EZ

NORTH AMERICAN
CYLINDER

sec 2 page 20

CORBIN/RUSSWIN

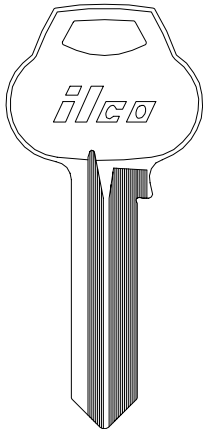

CR91

—

CRAFTSMAN

SEE
ELGIN

CUTLER

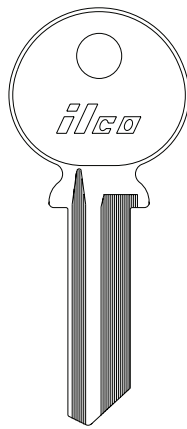

1181C

—

DEXTER / MASTER



1054KD

DE1

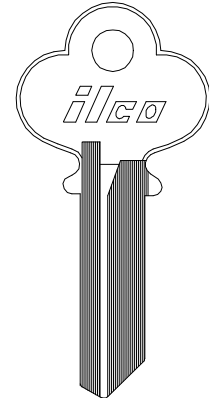

A1054KD

DE5

ILCO
EZ

DEXTER / MASTER

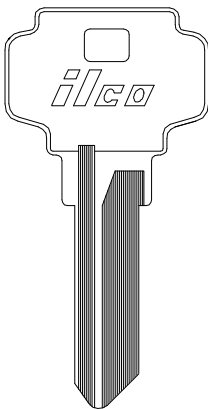

D1054K

DE6

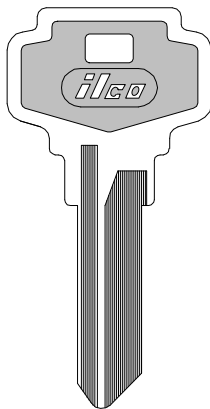

DE6-PC

—

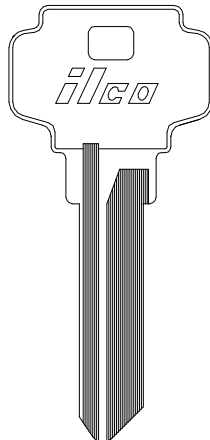

D1054KA

DE8

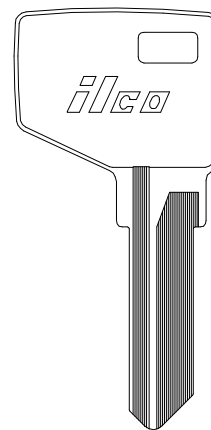

MD1054K

MD17

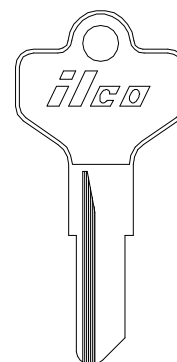

D1098B

DE2

ILCO
EZ

DEXTER / MASTER

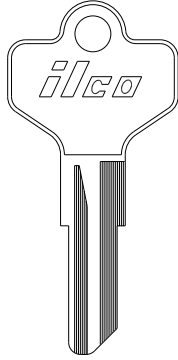
D1098BM

—

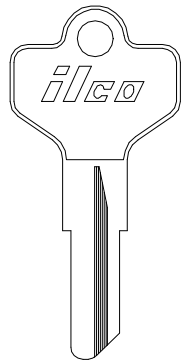
D1098X

DE4

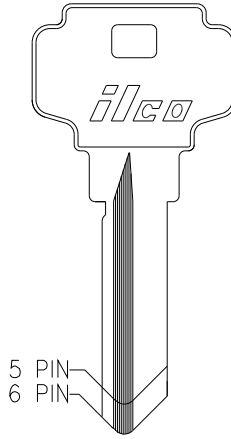

 5 PIN
6 PIN

D1145

—

D1145A

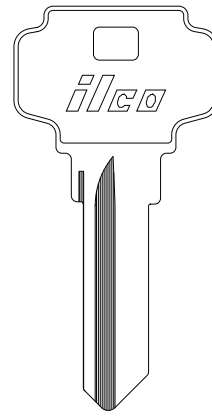
—

DS1145

DE9

 ILCO
EZ

 NORTH AMERICAN
CYLINDER

sec 2 page 21





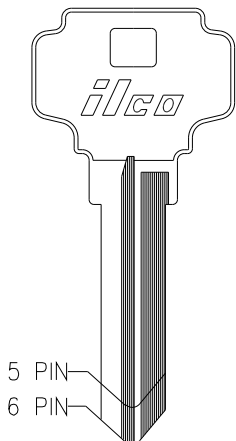
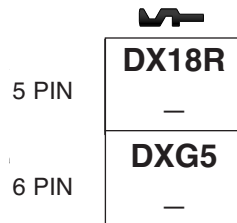
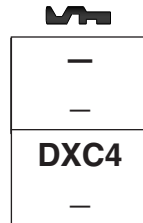
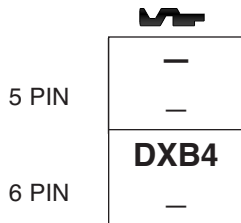

DEXTER / MASTER

5 PIN	DXB10	DXB20	DXB30	DXC10	DXC20	DXC30	DXD10	DXD20	DXD30
	—	—	—	—	—	—	—	—	—
6 PIN	DXB1	DXB2	DXB3	DXC1	DXC2	DXC3	DXD1	DXD2	DXD3
	—	—	—	—	—	—	—	—	—

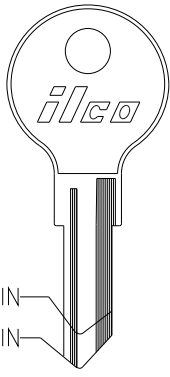
 5 PIN
6 PIN

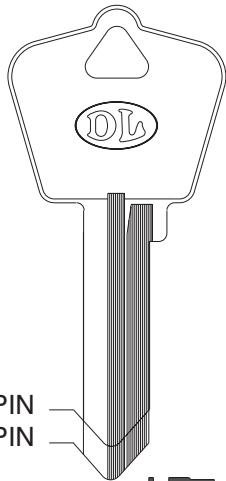
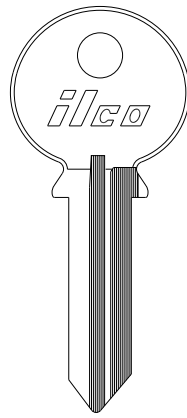
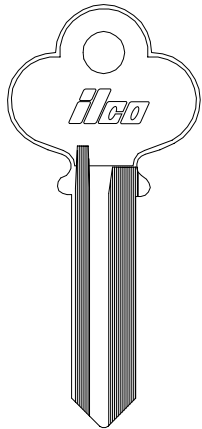
DOMINION LOCK





NORTH AMERICAN
CYLINDER

	5 PIN D03 —	6 PIN  D04 —			
5 PIN 6 PIN			5 PIN 6 PIN		
	5 PIN D01 —	6 PIN D02 —	5 PIN D05 —	6 PIN  D06 —	 5F —
				 22PO —	

ILCO
EZ

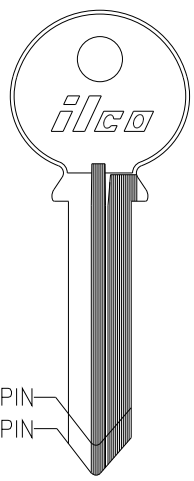
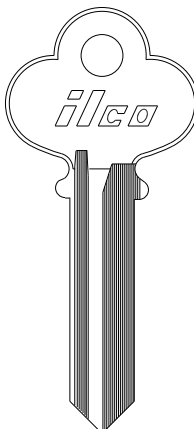
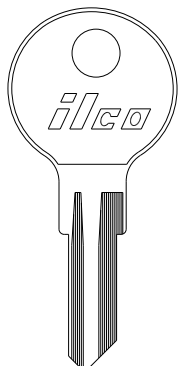
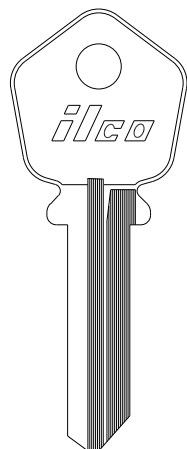
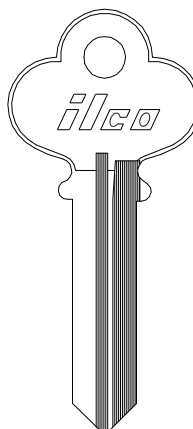





sec 2 page 22

DOMINION LOCK

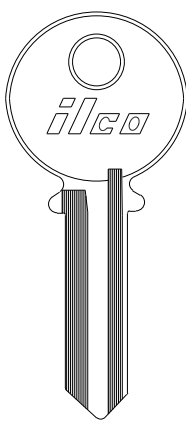
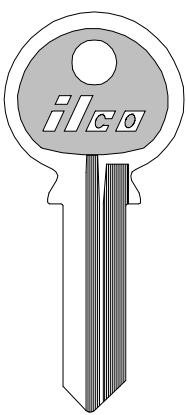
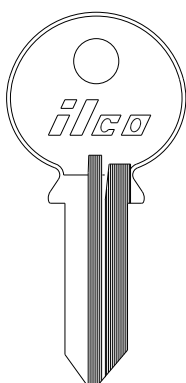
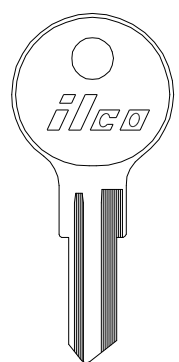
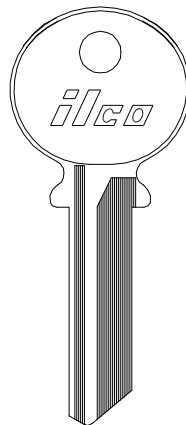
				
6 PIN 7 PIN				
6 PIN 54FA —	7 PIN 54FL —	 54KP —	 N54B —	 A54F —
				 P54F —

ILCO
EZ

DOMINION LOCK

				
				
S54F —	S54F-PC —	T54F —	N54G —	L54K —

ILCO
EZ

DOMINION LOCK

ILCO EZ						
	752	750	757	L1054B	H1054F	L1054F
	—	—	—	—	—	—

NORTH AMERICAN
CYLINDER

DONNER

DURA STEEL

DYNALOCK

EAGLE LOCK

ILCO EZ				SEE ILCO	
	1176 KW1	KW1-PC	H1054SR		1013
	—	—	—		—

EAGLE LOCK

ILCO EZ					6 PIN 1014A
					—
	1013C	1013DL	1013F	5 PIN 1014	—
	—	—	—	EA1	—

EAGLE LOCK

 5 PIN 1014DR —	 6 PIN A1014DR —	 1014K —	 1014CE —	 4 PIN 5 PIN 1014DS —	ILCO EZ
 5 PIN 1014D —	 6 PIN 1014DA —	 1014DB —	 4 PIN 5 PIN 1014DX —	EA13	

NORTH AMERICAN CYLINDER

sec 2 page 24

EAGLE LOCK

 1014F —	 1014J EA32	 1014JM —	 1014JS —	 L1014D —	 4 PIN O1014JS —	 5 PIN O1014J —	ILCO EZ
-----------------------	--------------------------	------------------------	------------------------	------------------------	----------------------------------	---------------------------------	-------------------

EAGLE LOCK

EAGLE PADLOCK

 4 PIN O1014JM —	 5 PIN O1014SM —	 O1014K —	 O1014P —	 O1014S —	 X1014F EA27	 1521 —	ILCO EZ
----------------------------------	----------------------------------	------------------------	------------------------	------------------------	---------------------------	----------------------	-------------------

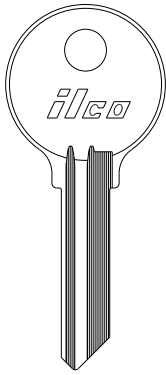
EAGLE PADLOCK
EARLE
ELGIN

1533

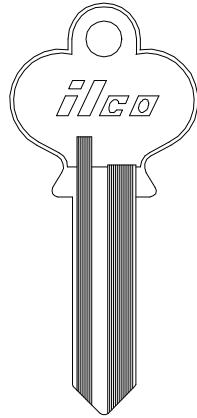
—

1119

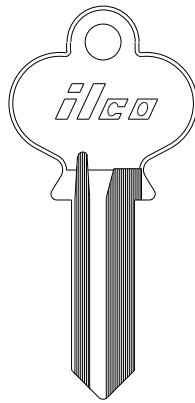
ER1

1119S

—

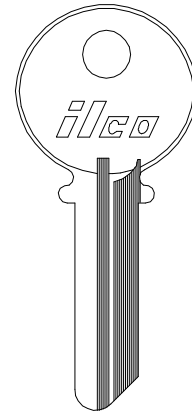
1096

EL2

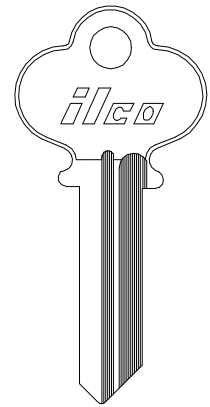
1096C

EL1

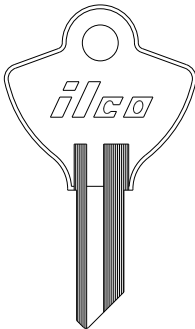
**ILCO
EZ**
ELGIN

1096EN

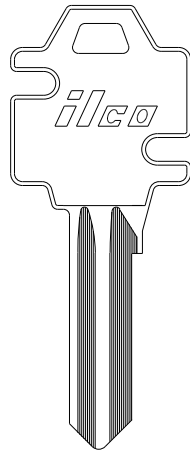
—

R1096EN

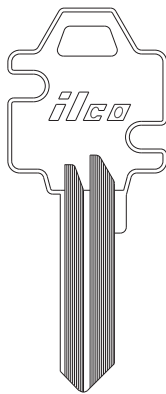
EL21

1096FL

—

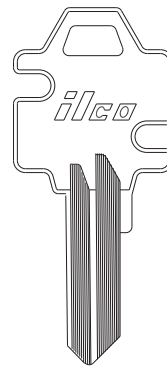
1096FM

—

1096FS

—

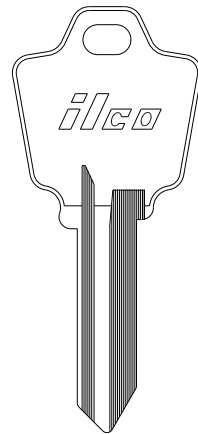

1096L

EL3

**ILCO
EZ**

1096NL

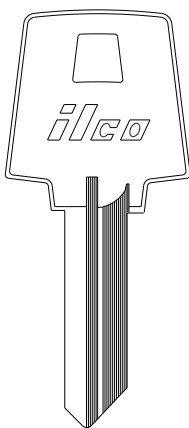
—

ELGIN

C1096C

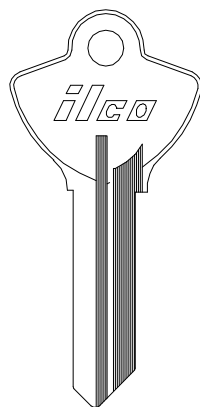
—

C1096CN

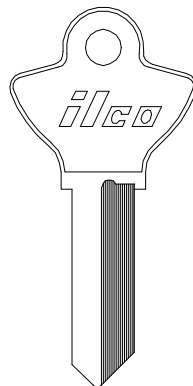
EL10

C1096LN

EL11

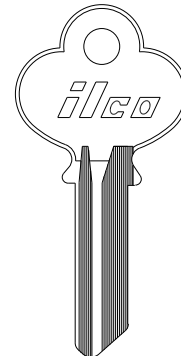
EB1096K

—

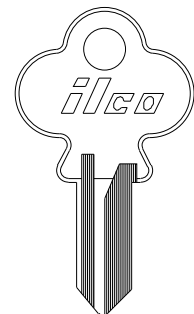



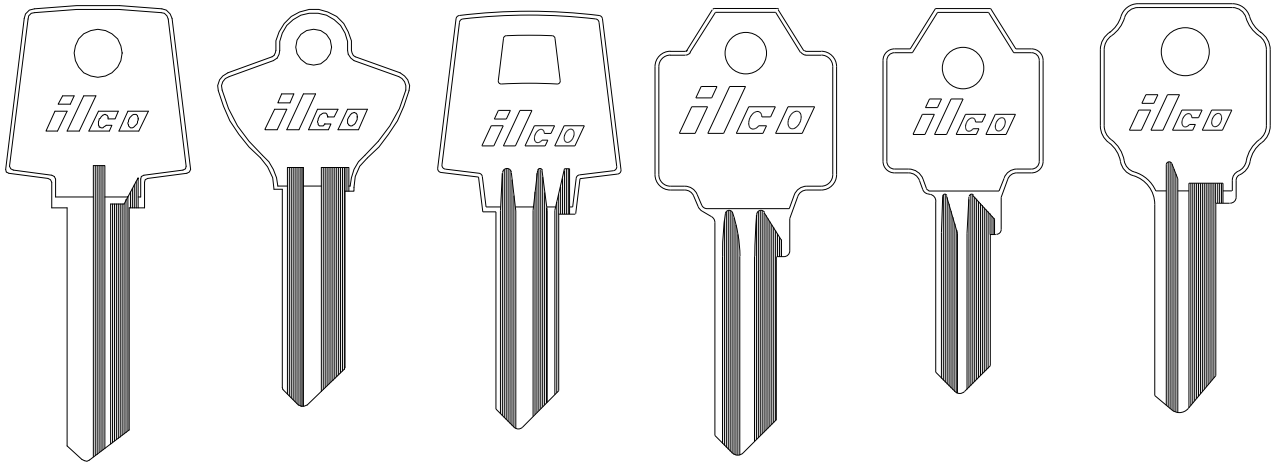

EO1096K

—

**ILCO
EZ**

ELGIN







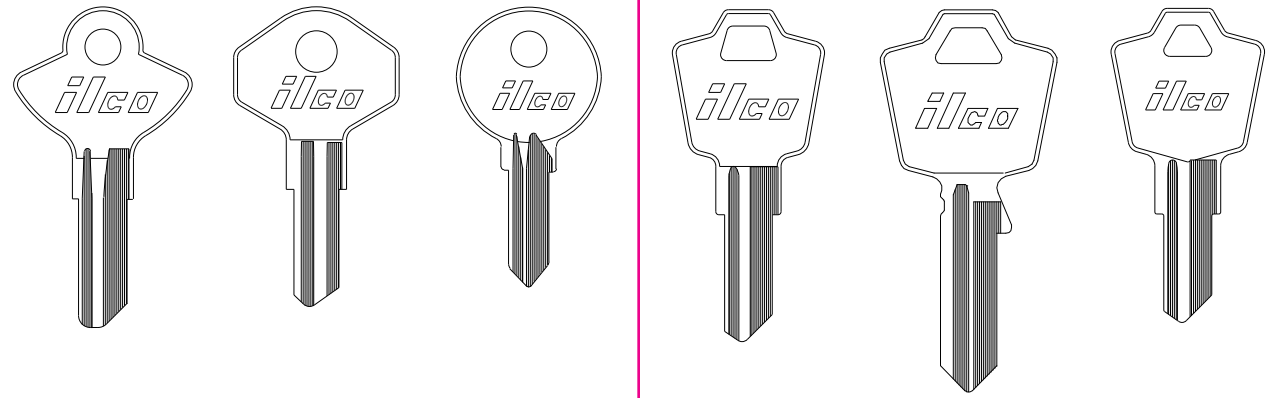

					
L1096CN EL15	S1096B EL20	S1096C —	S1096FL —	S1096FM —	S1096G —

ILCO
EZ

ELGIN ESP









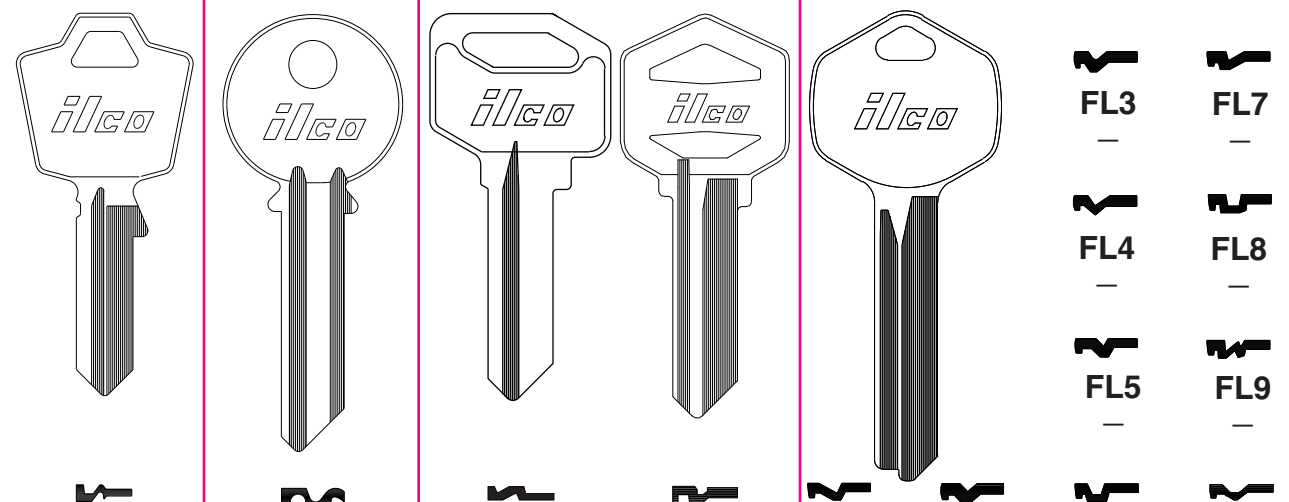







						
S1096JN —	S1096P —	1154C —	1502 —	1502M —	1503 ES9	1531 —

ILCO
EZ

ESP EXCEL EZ SET FALCON



							
1556 —	EX1 —	1647 EZ2	1522 EZ1	FL1 —	FL2 —	FL3 —	FL7 —
							
						FL4 —	FL8 —
							
						FL5 —	FL9 —
							
						FL6 —	FL10 —

ILCO
EZ

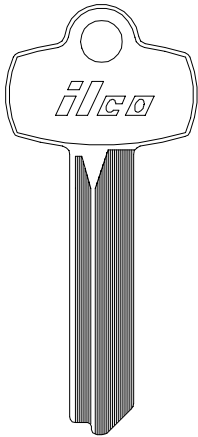
FALCON

(MASTER)
A1114FM

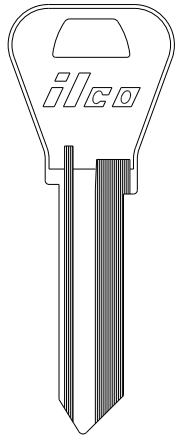

FL5G

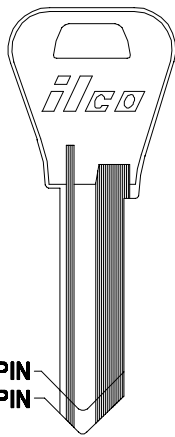

5 PIN 6 PIN
1054WB A1054WB
— WR4

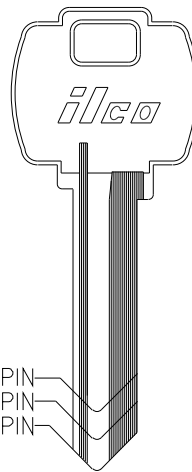

5 PIN
1054WC
FA1

6 PIN
A1054WC
FA2

7 PIN
L1054WC
—

ILCO
EZ

NORTH AMERICAN
CYLINDER

sec 2 page 27

FALCON

ILCO
EZ

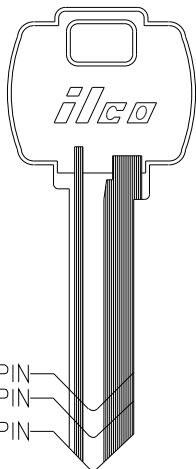
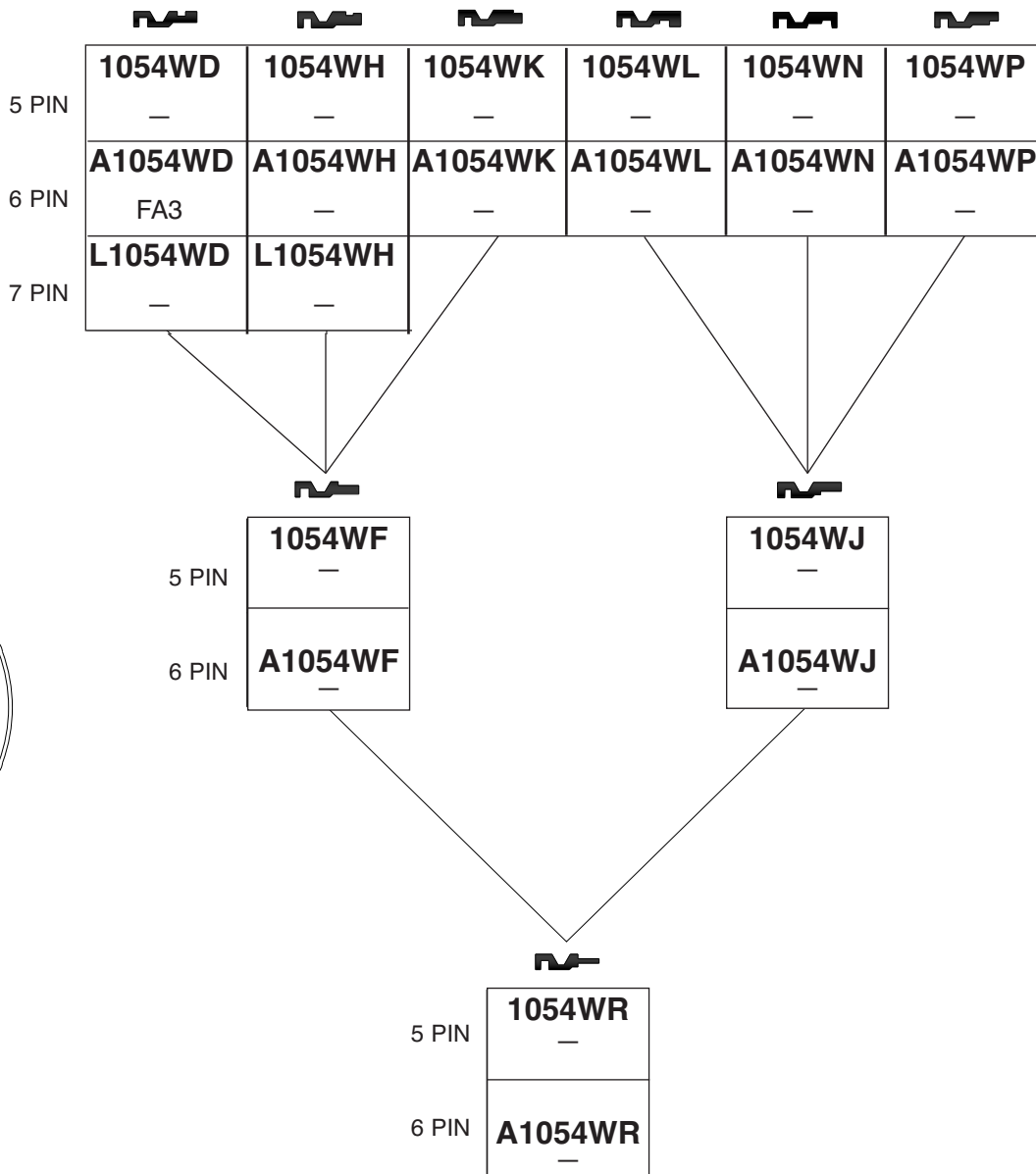

FANAL				FIC	FORT
R63	R64	1551	1552	1617 FIC1	M54G
—	—	—	—	—	—

ILCO
EZ

FORT					
ML54G	N54G	S54G	1054G	752	757
—	—	—	—	—	—

5 PIN
1054G
—
6 PIN
L1054G
FR2

4 PIN
5 PIN
6 PIN

ILCO
EZ

FORT		FRAIM	FULTON HITCH	
775	1137B	1073	1645	1645R
—	—	—	—	—

OD .377" - 9.6mm
ID .312" - 7.9mm
(BRASS)

ILCO
EZ

GENERAL

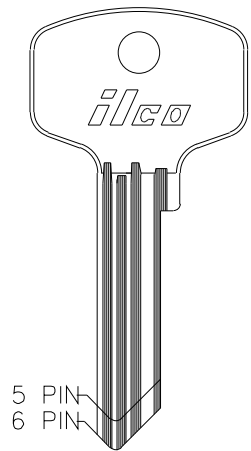

5 PIN	G191 —	G192 —	G193 —	G194 —
6 PIN	G191A —	G192A —	G193A —	G194A —

5 PIN	G190B —
6 PIN	G190BA —

ILCO
EZ

NORTH AMERICAN
CYLINDER

sec 2 page 29

GENERAL

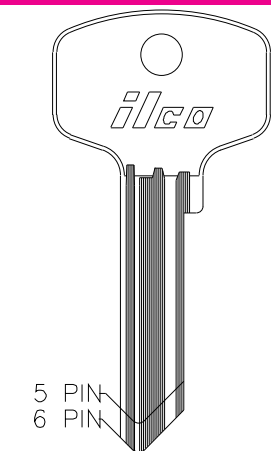

5 PIN	G191 —	G195 —	G196 —	G197 —
6 PIN	G191A —	G195A —	G196A —	— —

5 PIN	G190C —
6 PIN	G190CA —

ILCO
EZ

GENERAL

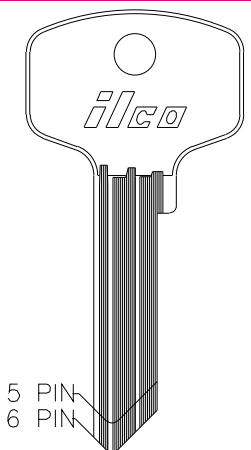

5 PIN	G192 —	G195 —	G198 —	G199 —	G193 —	G196 —	G198 —	G190 —
6 PIN	G192A —	G195A —	— —	— —	G193A —	G196A —	— —	G190A —

5 PIN	G190D —
6 PIN	G190DA —

5 PIN	G190E —
6 PIN	G190EA —

ILCO
EZ

GENERAL

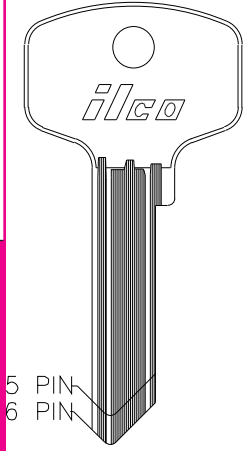

5 PIN	G194	G197	G199	G190
	—	—	—	—
6 PIN	G194A	—	—	G190A
	—	—	—	—

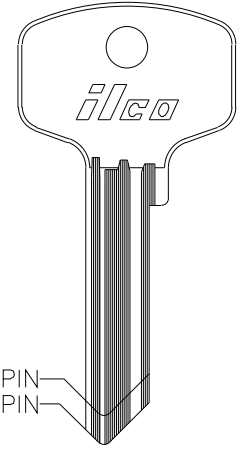

5 PIN	G190F
	—
6 PIN	G190FA
	—

5 PIN	G190M	G190MA
	—	—

ILCO
EZ

NORTH AMERICAN
CYLINDER

sec 2 page 30

GENERAL

GENERAL FIRE
PROOF SAFE

HARLOC

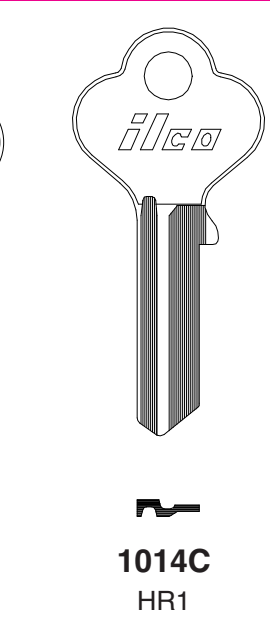
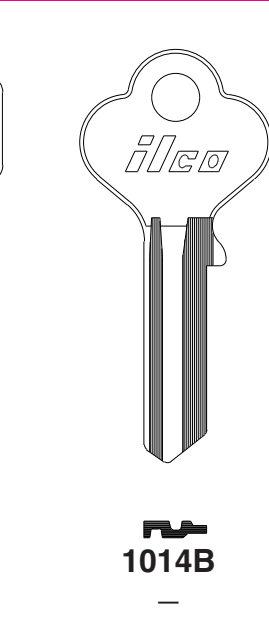
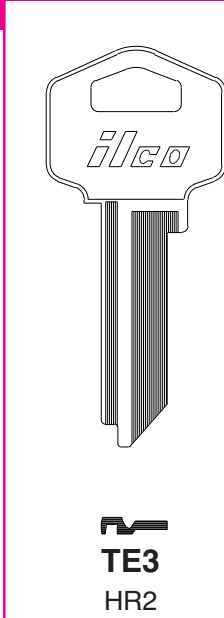
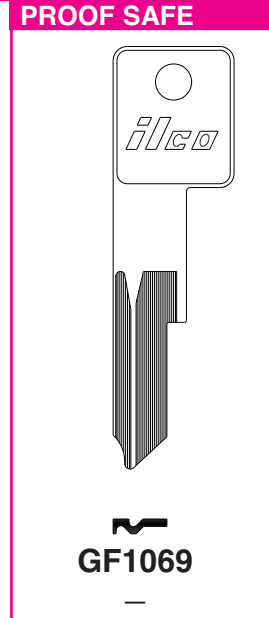
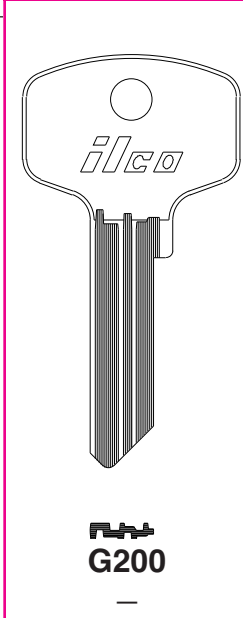

ILCO
EZ

HARLOC

HAWORTH

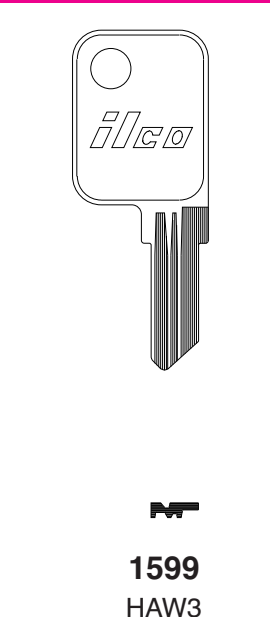
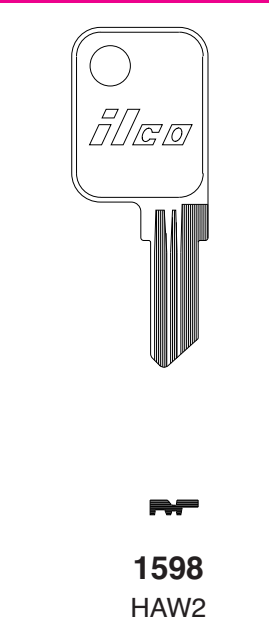
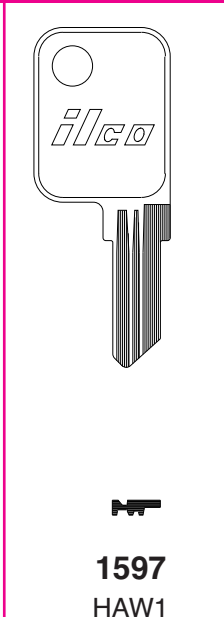
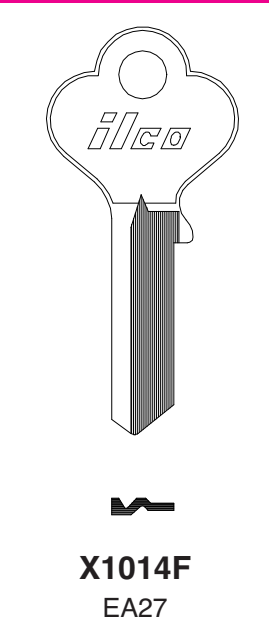
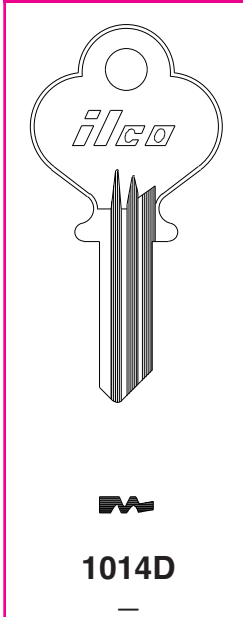

ILCO
EZ

HAWORTH

HUBER

HUDSON

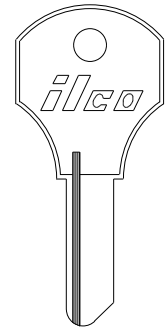
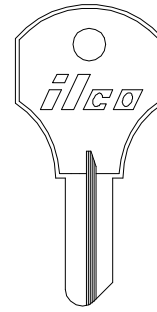
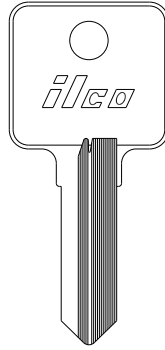
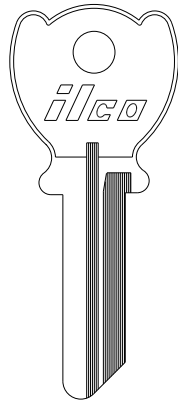
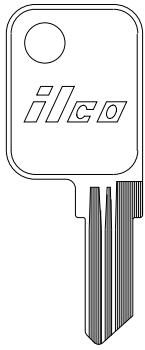

5 DISC

6 DISC



1600
HAW4

1020
—

HL3
—

S1000V
CO68

1000V
CO26

1000X
CO63

1000XK
—

ILCO
EZ

HUDSON

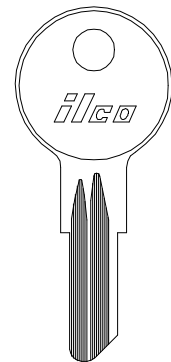
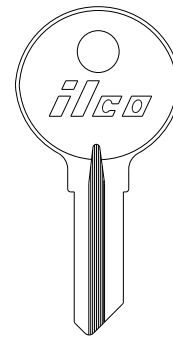
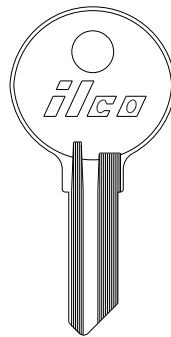
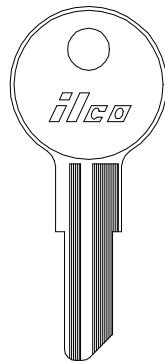
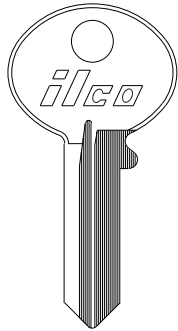

1003M
CO106

R1003M
BO1

1041T
CG16

1069
RO1

1069B
—

1098DB
B5

ILCO
EZ

HUDSON

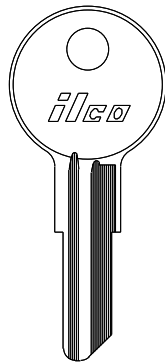
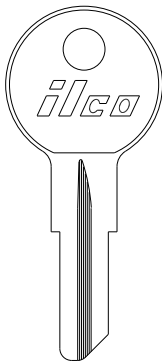

O1122A
Y12

O1122AR
Y14

O1122B
Y103

O1122BR
—

O1122BE
—

O1122C
—

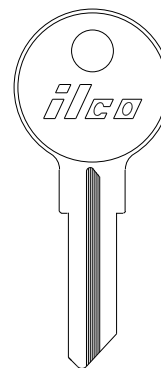

1562
—

1563
—

1564
—



1098X
—

O1122
Y11

O1122R
Y13

1561
—

ILCO
EZ

HUDSON HURD

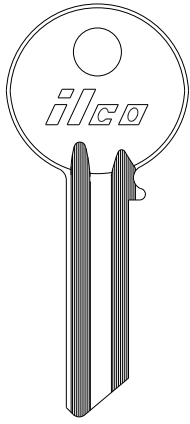

1512

—

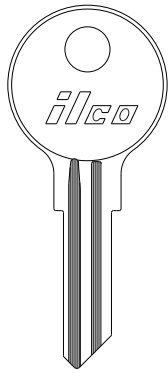

1525

—

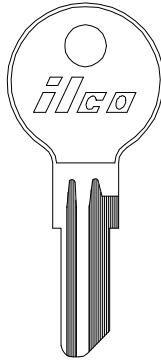

O1122A

Y12



O1122B

Y103

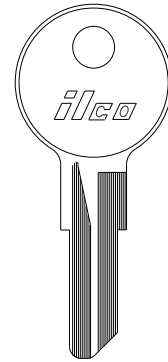

O1122C

—

ILCO
EZ

HURD

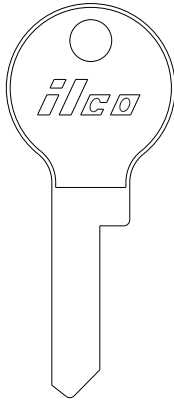

1125

H6

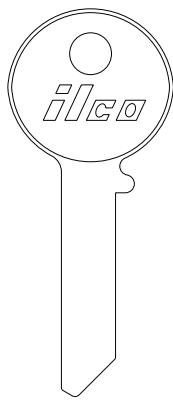

1125A

—

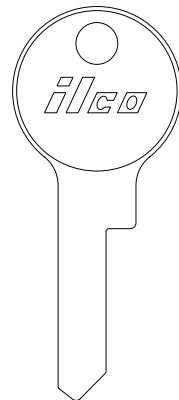

1125D

—

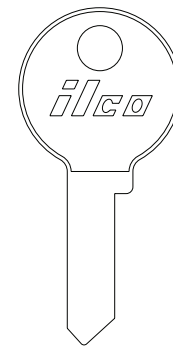

D1125

—

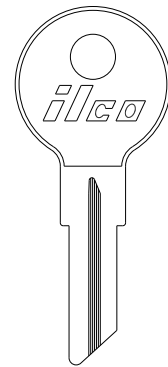

1125X

—

ILCO
EZ

HURD IDEAL

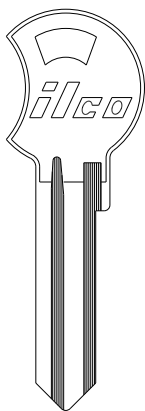

GP1125

—

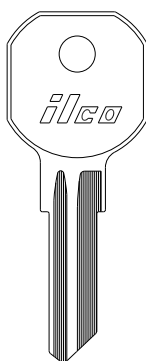

1536

—



1536R

—



1574

—



1574R

—

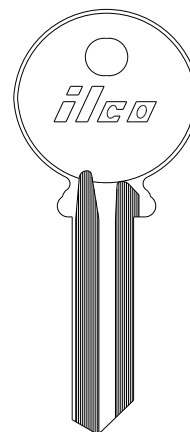

ID1

—

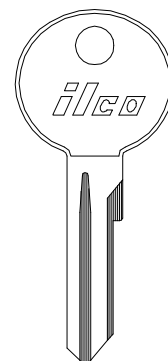

IS1

—

ILCO
EZ

IDEAL

ILCO

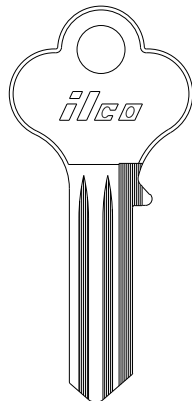
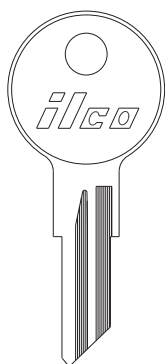
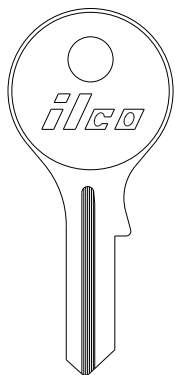
 ILCO
EZ

64D

64RD

64G

1538

C20

C21

ILCO

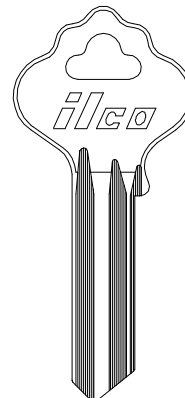
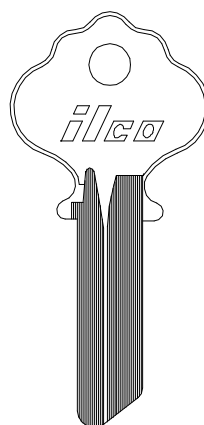
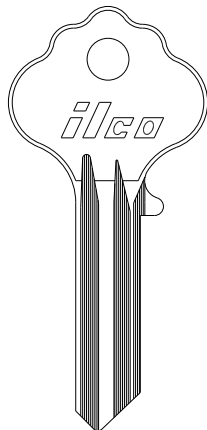
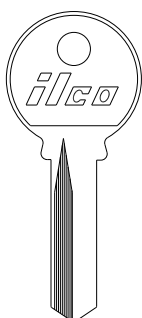
 ILCO
EZ

C22

X1053

1054

1054DL

—

—

IN2

IN35

ILCO

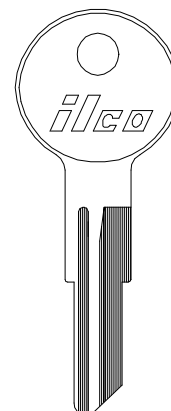
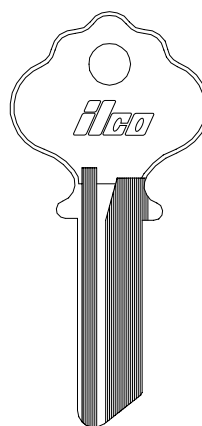
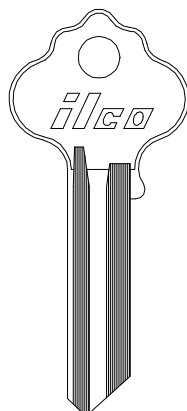
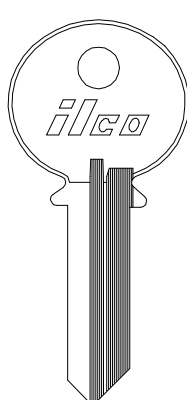
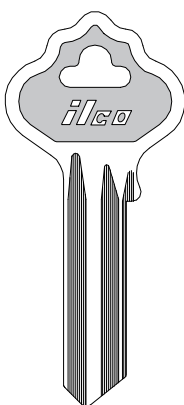
 ILCO
EZ

IN35-PC

1054F

1054FN

1054K

1054LB

—

IN1

IN28

—

IN4

ILCO

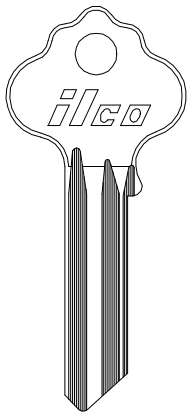

1054MT
IN33

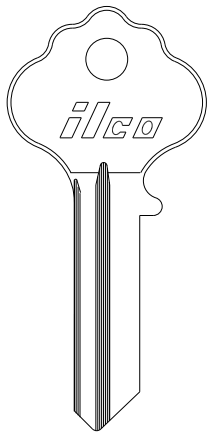

1054R
—

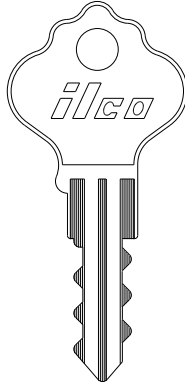

1054N*
—

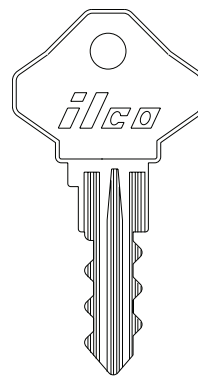

1054P*
—

* NOTE: This special blank is not a cut key. It is to be used the same as regular blanks for duplicating, cutting from code or from depth keys. It will save the locksmith 80% of his work, and the key can be cut more accurately and in less time. After cutting the special blank, when compared with the original keys, they will not be exactly alike in the pass cut positions, but this is not important as long as they match with the original where the tumblers rest on the key.

ILCO
EZ

ILCO

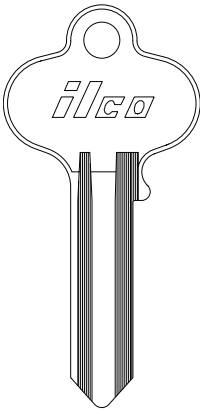

1054TW
IN34

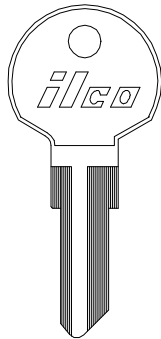

1054UN
IN29

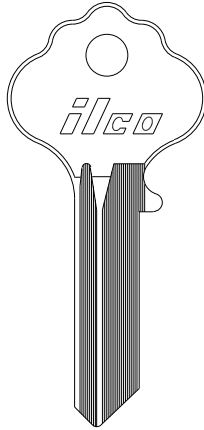

1054X
—



B1054B
—

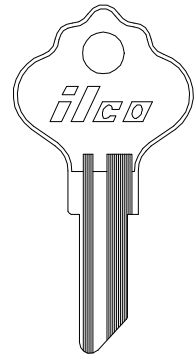

H1054B
EL8

ILCO
EZ

ILCO

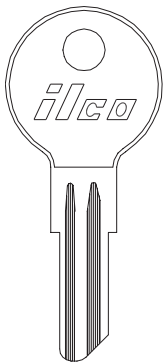

H1054S
—



H1054L
—

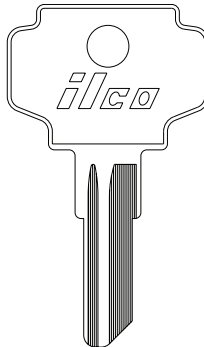

K1054B
IN24

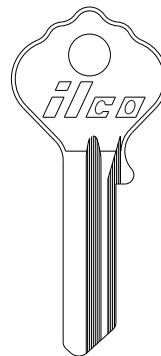

L1054AR
—

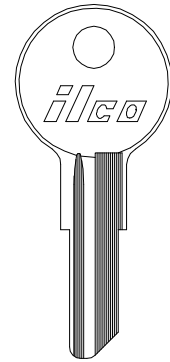

L1054B
IN8

ILCO
EZ

ILCO

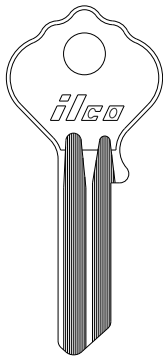

L1054JA



L1054JK

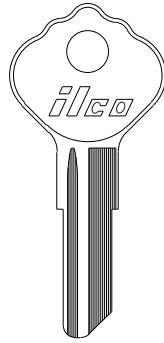

M1054B

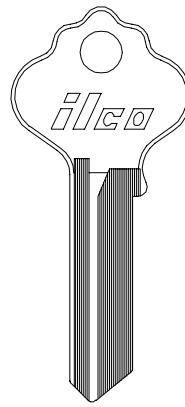

N1054K

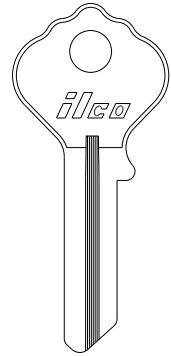

X1054AR



ILCO
EZ

ILCO

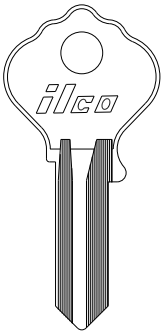

X1054BK

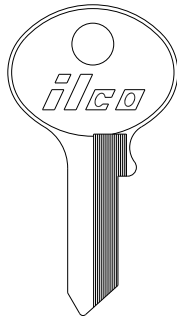

X1054C

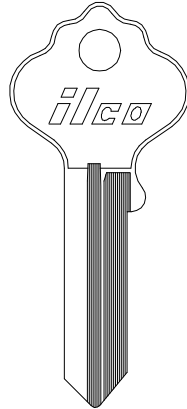

X1054F



X1054GA



X1054GB



ILCO
EZ

ILCO

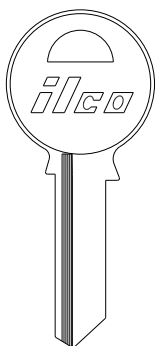

X1054GC

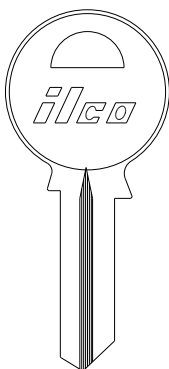

X1054GD

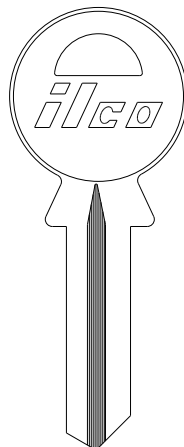

X1054GE

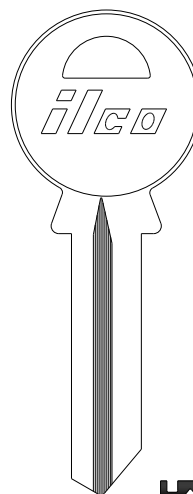

X1054GF

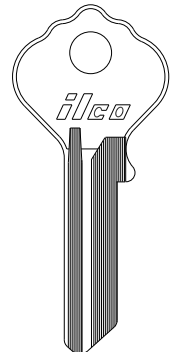

X1054JA



ILCO
EZ

ILCO

			 X1054KR —	
			 X1054LF —	
			 X1054LR —	
 X1054JK —	 X1054K IN3	 X1054KF —	GOVERNMENT PADLOCKS	 X1054SC —

ILCO
EZ

ILCO

	 X1055GB —			
	 X1055JK —			
	 X1055JR —			
 X1055GA —	GOVERNMENT PADLOCKS	 1092TG-ILCO —	1118 —	 1125A —

ILCO
EZ

ILCO

OD .377" - 9.6mm ID .312" - 7.9mm (BRASS) 1137B —	 1154C —	 1154G —	 1154GR —

ILLINOIS

 ILL1 —	 ILL2 —	 1041H IL1	 1041HM —

ILCO
EZ

ILLINOIS

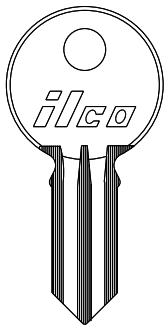
 1041P
—

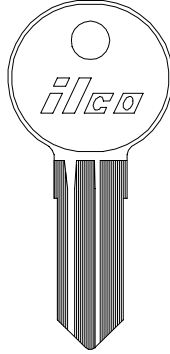
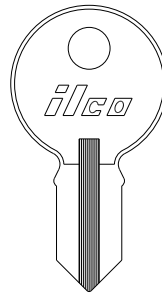
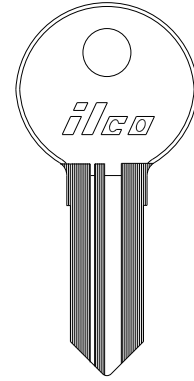
 1041S
—

 1041W
—

 S1041H
—

 1042A
—

 1042B
—

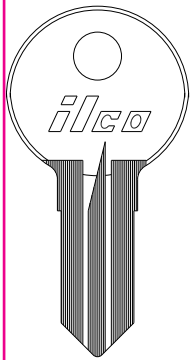
 1042Z
—

 ILCO
EZ

ILLINOIS



 S1042ZM
—

 S1042ZP
—

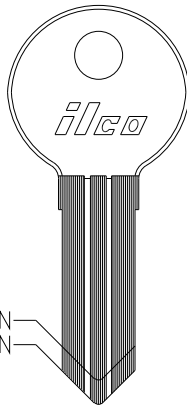
 S1042ZS
—

 5 PIN

 1041WC
—

 1043C
—

 1043D
—

 1043E
—

 S1042Z
—

 5 PIN 6 PIN

 L1042A L1042B
— —

 1043ED
—

 1043B
IL9
—

 1043G
—

 ILCO
EZ

ILLINOIS

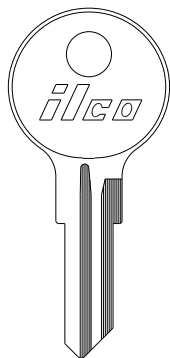

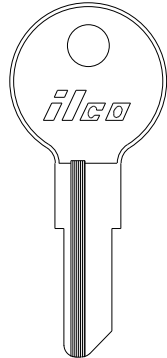
 1043F
—

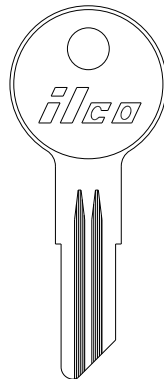
 1043J
IL11

 1043V
—

IMPORT

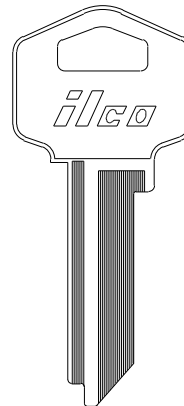

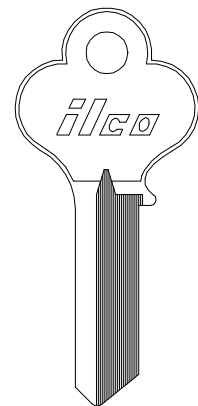
 TE3
HR2

 X1014L
LO1

 ILCO
EZ

 NORTH AMERICAN
CYLINDER

sec 2 page 37

IMPORT



1528	1528R	1537	1538	1541	1566
—	—	CLP1	—	—	—

ILCO
EZ

IMPORT G. R. KEY CO.

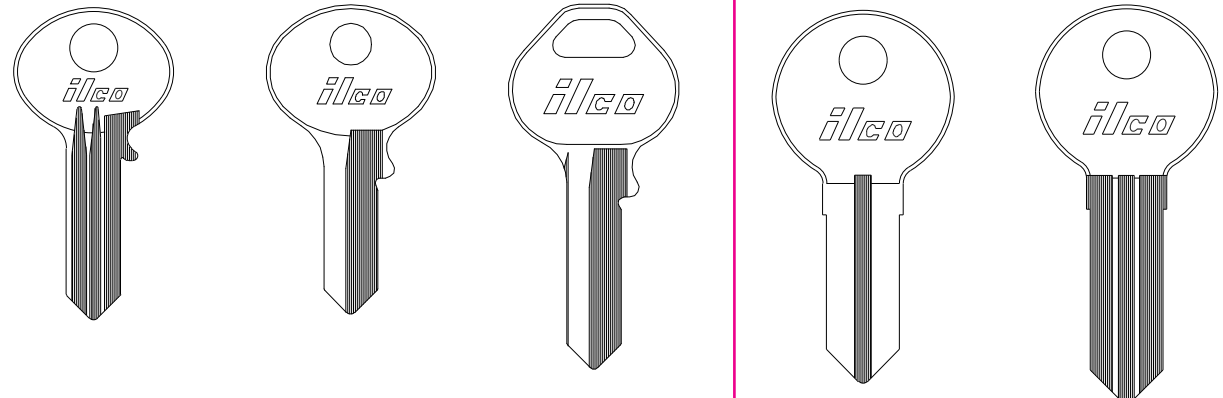

1571	1092TG-ILCO	1092NTG	1042M	L1042M	L1042B
—	—	—	—	—	—

ILCO
EZ

KEIL KIMBALL

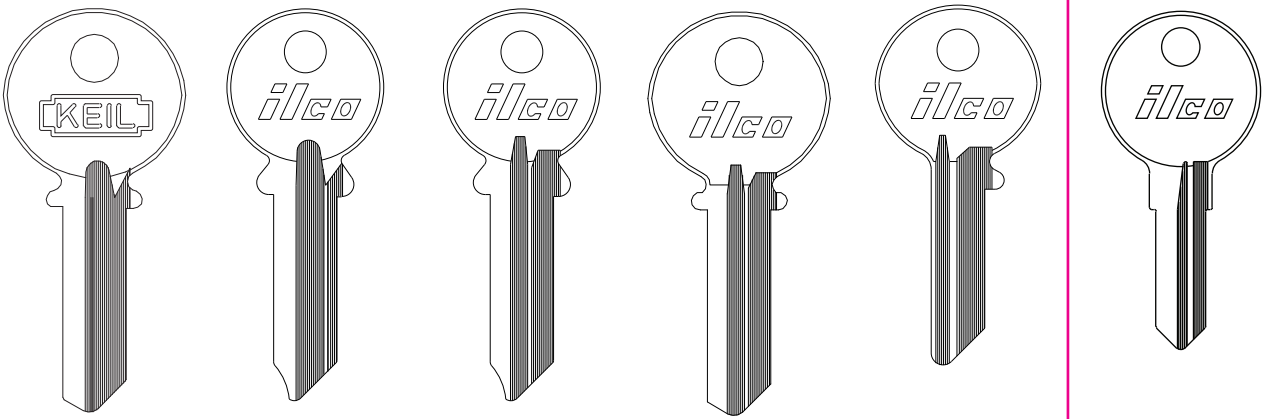

1079	1079A	1079AB	1079B	1154ES	1649
K1	—	—	K2	—	KB1

ILCO
EZ

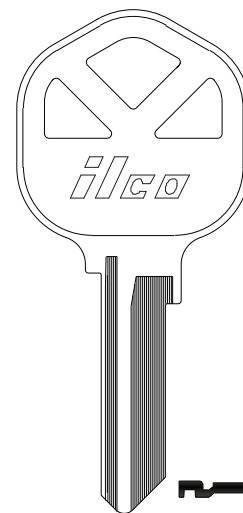
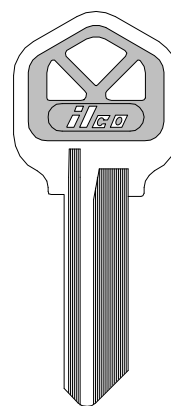
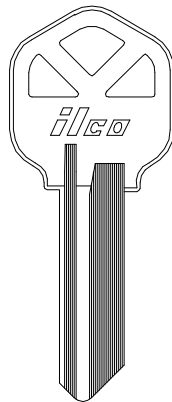
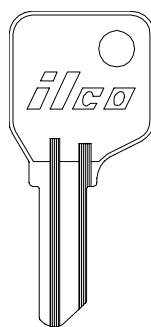
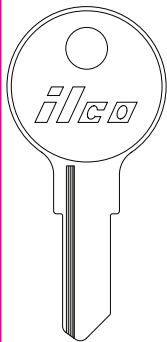
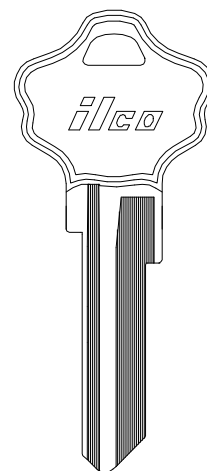
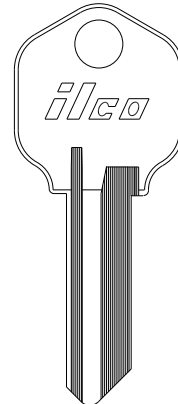
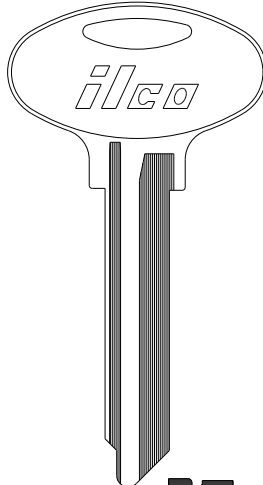
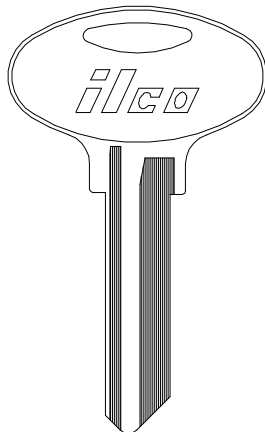
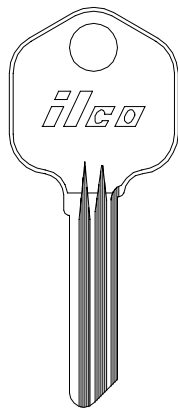
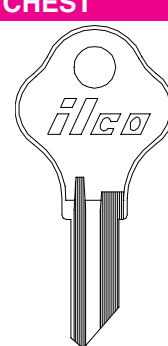
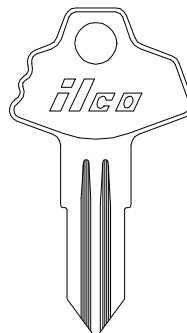
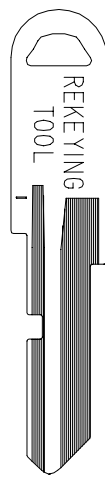
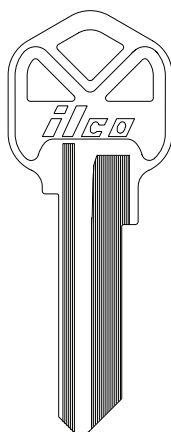
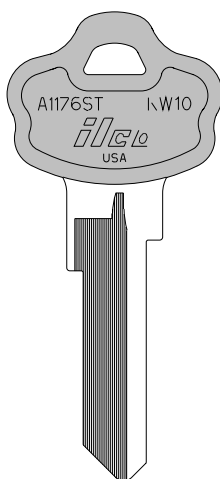
KIMBALL
KRYPTONITE
KWIKSET

**ILCO
EZ**
**1654
KB2**
**1663
KB3**
**1567
—**
**1176
KW1**
**KW1-PC
—**
**KW1-BIG
—**
KWIKSET

**ILCO
EZ**
**1176D
—**
**A1176
KW5**
**CR1176
—**
**S1176
—**
**A1176ST
KW10**
KWIKSET
LAGARD
**LANE CEDAR
CHEST**
LARSON DOOR

**ILCO
EZ**
**KW10-PC
—**
**A1176KT
KW11**
**1176RK
—**
**S900
—**
**LC1069
—**
**1639
LD1**

NORTH AMERICAN CYLINDER

sec 2 page 40

LARSON DOOR	LOCK MEXICO		LOCK-O-PHONE LOCKWOOD	
				 6 PIN 1004A L4 7 PIN 1004AL — 5 PIN 1004 L1
1640 LD2	1553 —	1585 —	1154L —	1004 L1

ILCO EZ

LOCKWOOD				
5 PIN 6 PIN	5 PIN 6 PIN	5 PIN 6 PIN	5 PIN 6 PIN	5 PIN 6 PIN
1004AX	1004AXA	1004XM	1004AXM	1004K
—	—	—	—	—

ILCO EZ

LOCKWOOD				
5 PIN 6 PIN	5 PIN 6 PIN	5 PIN 6 PIN	5 PIN 6 PIN	5 PIN 6 PIN
1004M	1004N	1004R	1004AR	1004SN
—	L13	—	—	—

ILCO EZ

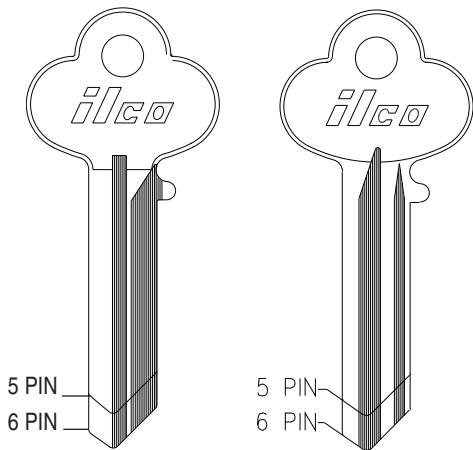
LOCKWOOD

5 PIN 6 PIN 5 PIN 6 PIN
1015 1015A 1015C A1015C

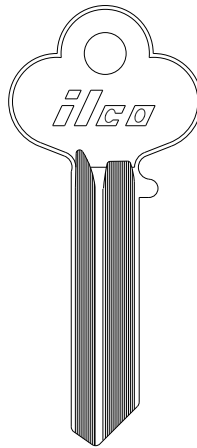

(MASTER)
 6 PIN
A1015M

A1015L	A1015R	A1015V
-	-	-
A1015N	A1015S	A1015W
-	-	-
A1015P	A1015T	A1015X
-	-	-
A1015Q	A1015U	A1015Y
-	-	-

ILCO
EZ

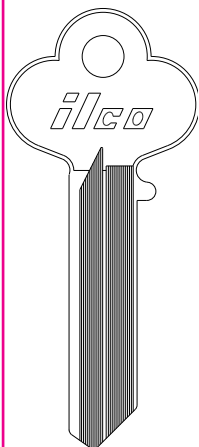
LOCKWOOD
LSDA

(MASTER)

A1015MR

A1015LR	A1015RR	A1015VR
-	-	-
A1015NR	A1015SR	A1015WR
-	-	-
A1015PR	A1015TR	A1015XR
-	-	-
A1015QR	A1015UR	A1015YR
-	-	-

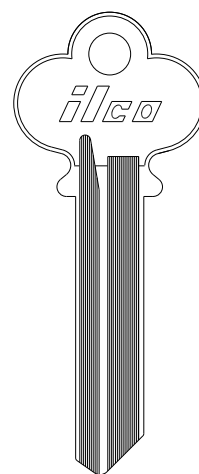

7 PIN 7 PIN

L1015M L1015MR
 -(MASTER)-

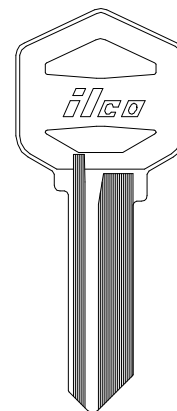

1522
 EZ1

ILCO
EZ

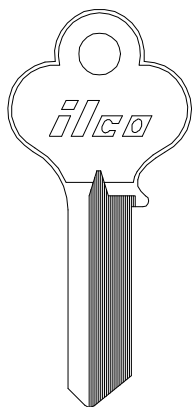
LORI
MASTER

X1014L
 LO1

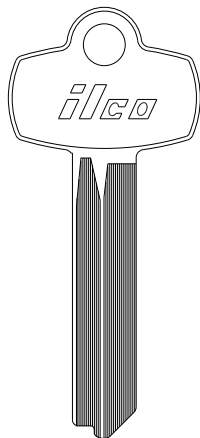

1615
 -

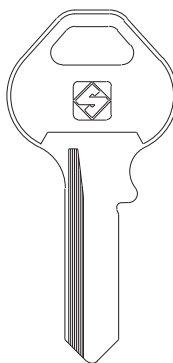

MS4R
 -

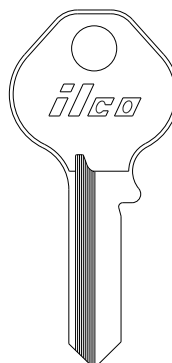

MA7
 -



1092
 M1



1092R
 -



M1-PC
 M1-PC

ILCO
EZ

MASTER

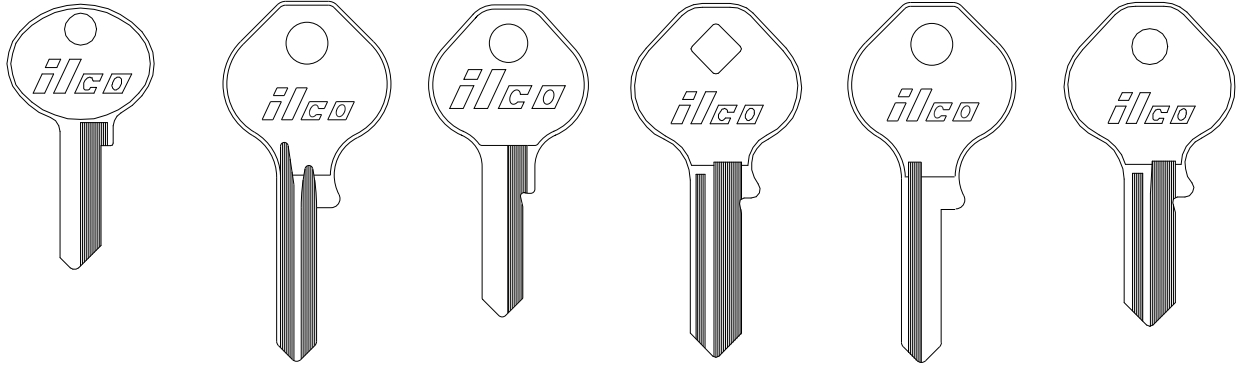

1092B M2	1092C M17	1092CNTLBI —	1092D M12	1092DD —	1092E —	1092DS M13

ILCO
EZ

MASTER



1092F M27	1092H M11	1092J M14	1092K M28	1092N M10	1092NR M16	1092V M4

ILCO
EZ

MASTER

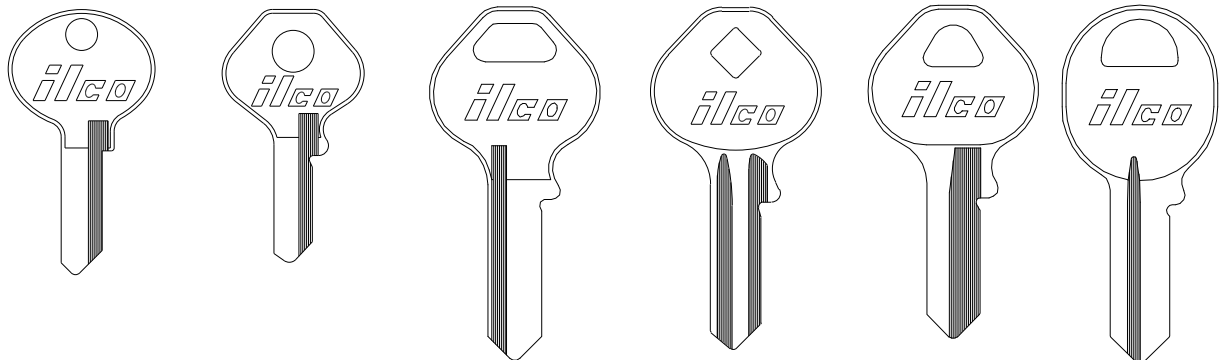

1092VA —	1092VR M3	1092VB —	1092VM M5	1092-40 M18	1092-52 —	1092-600A —

ILCO
EZ

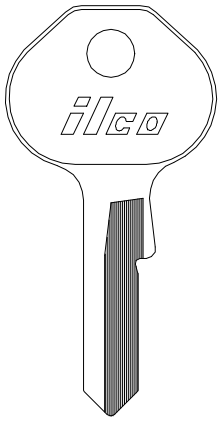
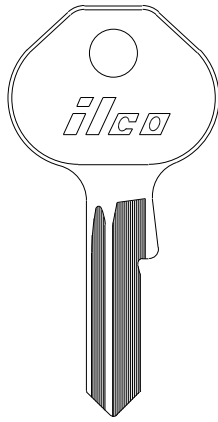
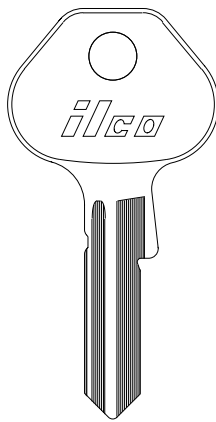
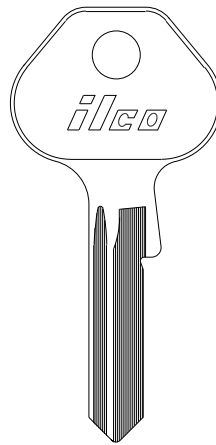
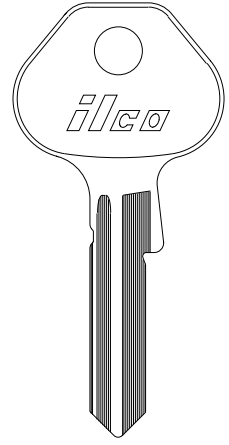
MASTER

1092-900
M19

1092-6000
M20

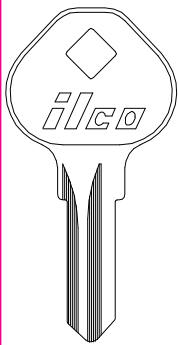
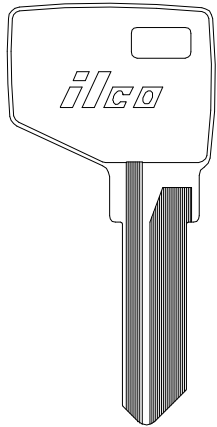
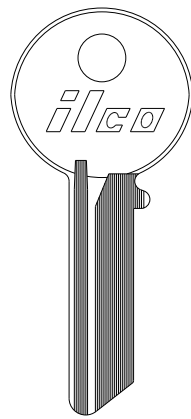
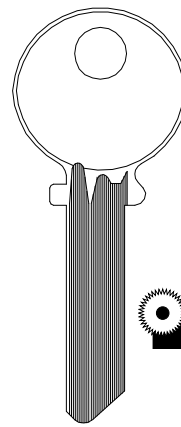
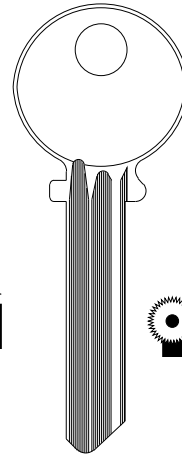
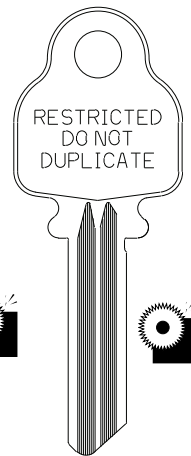
1092-6000B
M25

1092-7000
M21

1092-7000B
M26

ILCO
EZ

NORTH AMERICAN
CYLINDER

MASTER
MCKINNEY
MEDECO

1092-8105
—

MD1054K
—

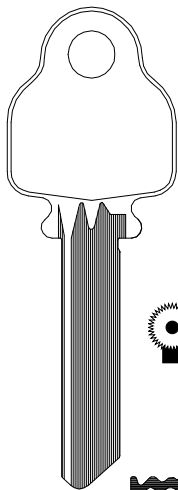
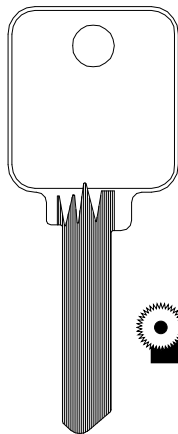
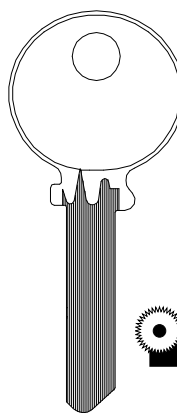
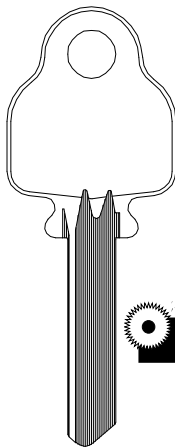
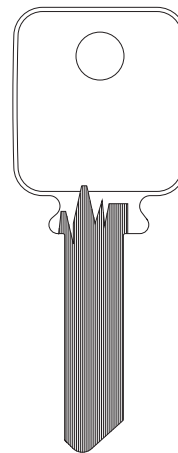
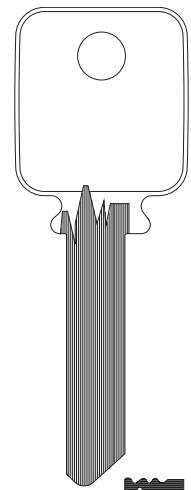
O1054K O1054KR
—

1515
—

A1515
—

1517
—

ILCO
EZ

sec 2 page 43

MEDECO

A1517
—

1518
—

1542
—

1543
—

1638
—

A1638
—

ILCO
EZ

NORTH AMERICAN CYLINDER

MEDECO		METALROUSSEAU					
1644	1655	MR1	5 PIN MR3	6 PIN MR2	4 PIN H64S	5 PIN H64	M64
—	—	—	—	—	—	—	—

ILCO
EZ

sec 2 page 44

MINTCRAFT PADLOCK NATIONAL CASH REGISTER						
1643	NC1	NC2	NC3	NC96K	NC96M	
—	—	—	—	—	—	

ILCO
EZ

NATIONAL CASH REGISTER							
X1000FR	1083	1083C	1083H	1083J	1083K	1083P	
—	—	—	—	—	—	—	
					1083L	1083R	
					—	—	
					1083M	1083S	
					—	—	
					1083N	1083T	
					—	—	

ILCO
EZ

NATIONAL E-Z SET

NCL

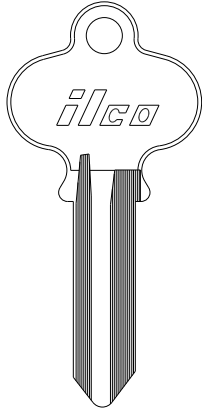

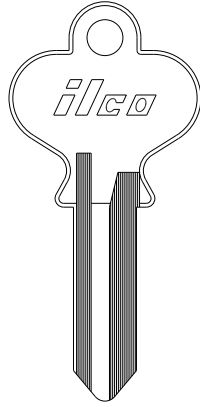

177
—



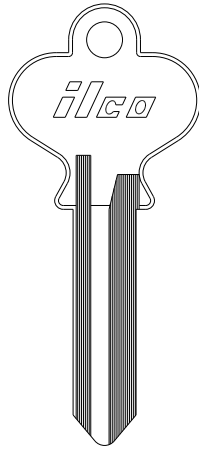

1177
—

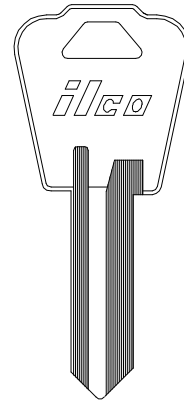

1177A
—



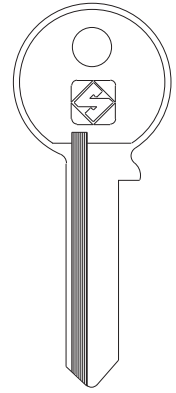

1177N
NH1



NCR1R
—

ILCO
EZ

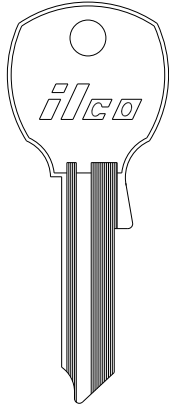
NCL / NATIONAL CABINET





1028NR
—



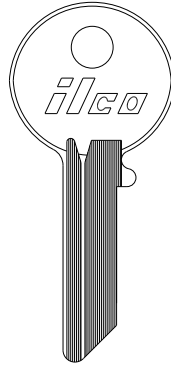

1064
NA1

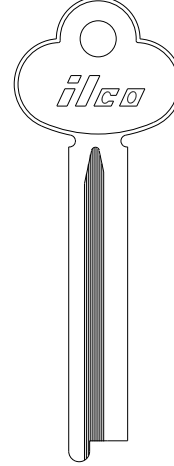

1064A
—



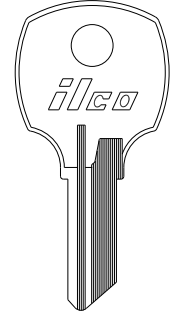

1064L
—



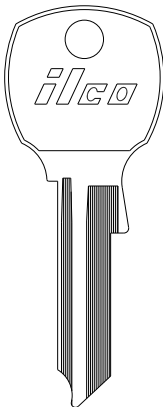

1064M
—

ILCO
EZ

NCL / NATIONAL CABINET

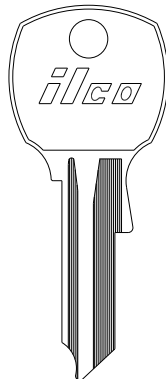

L1064C
—





S1064A
—



1065
—



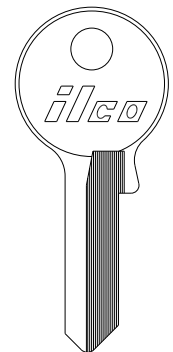

1065C
—



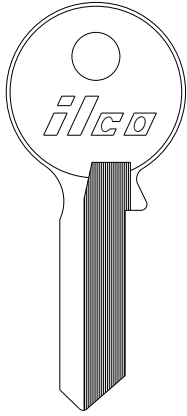

1065D
—

ILCO
EZ

NCL / NATIONAL CABINET

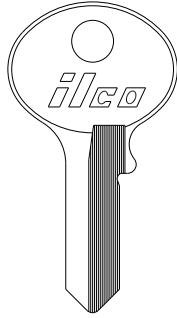

1065E
—



1065F
—

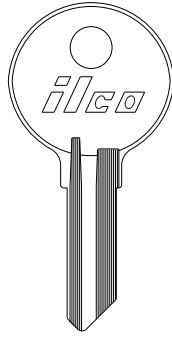

1069
RO1

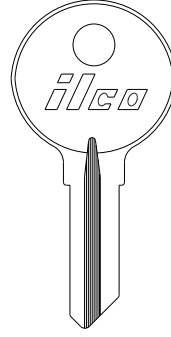

1069B
—

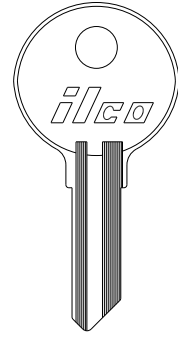

1069C
—

ILCO
EZ

NORTH AMERICAN
CYLINDER

sec 2 page 46

NCL / NATIONAL CABINET



1069D
—

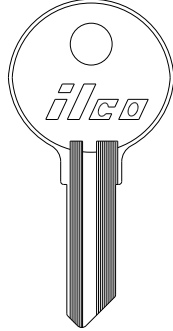

1069E
RO14

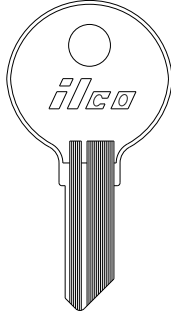

1069F
—

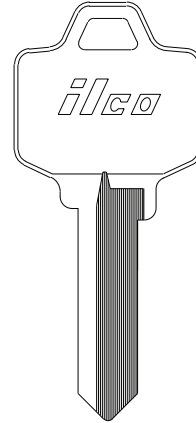

1069FN
—

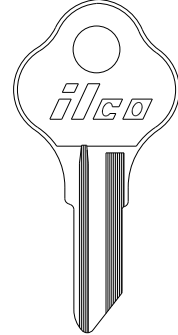

1069FNA
—

ILCO
EZ

NCL / NATIONAL CABINET

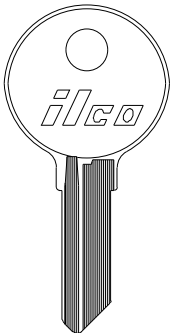

1069FL
RO4

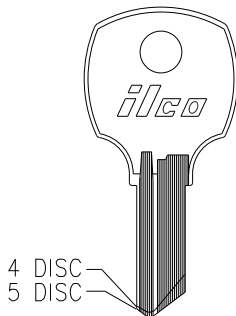

1069G
—

1069G
RO7

4 DISC 5 DISC

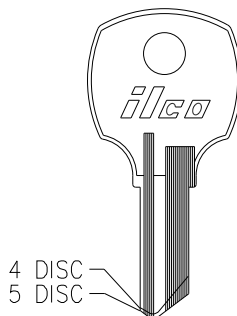

1069H
—

1069H
RO11

4 DISC 5 DISC

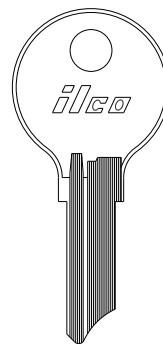

1069HN
—



1069L
NA14

R1069L
—

ILCO
EZ

NCL / NATIONAL CABINET

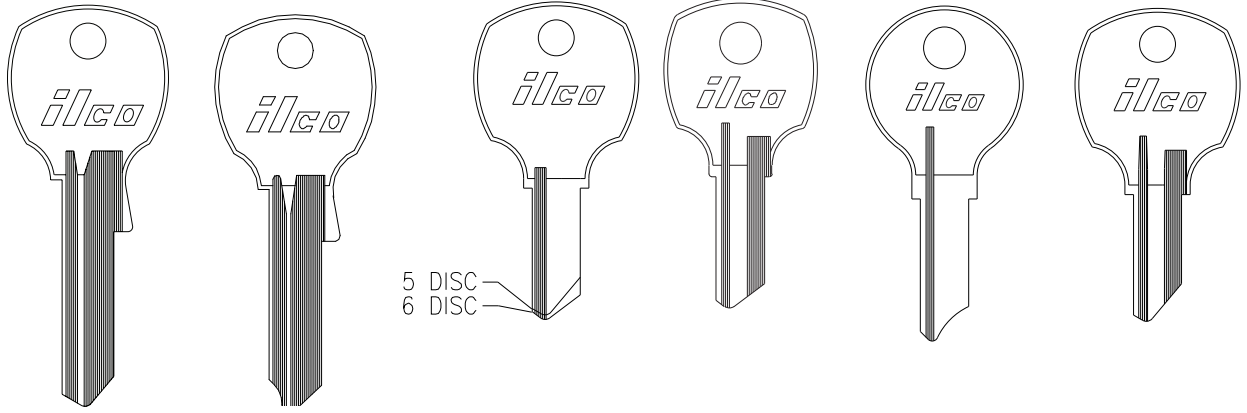

	1069LA	1069LB	1069LC	S1069M	1069M	1069N	1069P
	—	NA12	NA24	—	RO5	RO3	—

ILCO
EZ

NORTH AMERICAN
CYLINDER

NCL / NATIONAL CABINET

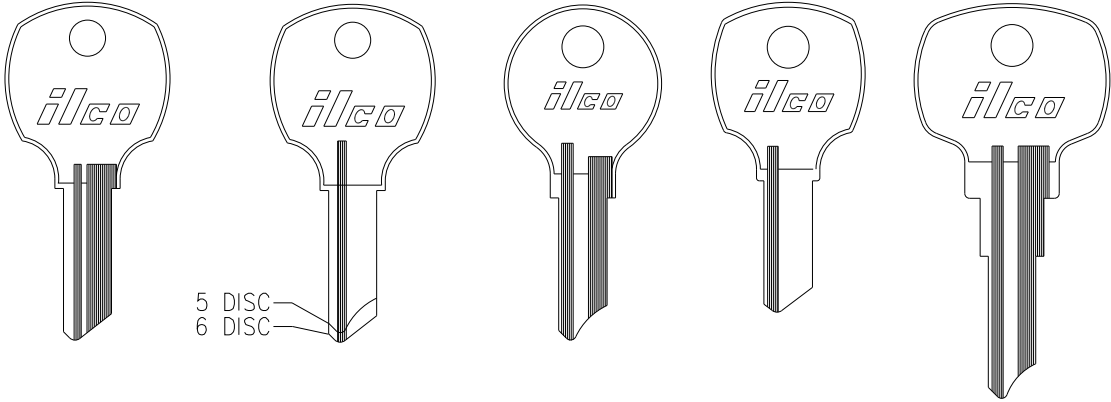

	1069SM	S1069T	1069T	1069W	1069YM	1069-5Y
	—	—	—	—	—	—

ILCO
EZ

sec 2 page 47

NCL / NATIONAL CABINET

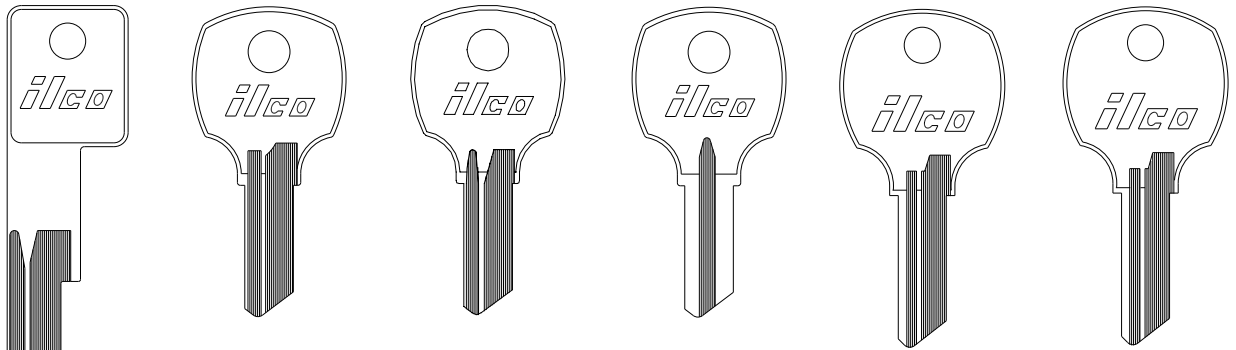

	GF1069	M1069C	M1069L	N1069B	N1069C	N1069E
	—	—	—	RO13	—	—

ILCO
EZ

NCL / NATIONAL CABINET



N1069G

—



N1069J

—



N1069N
RO15

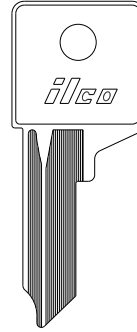

1544

—

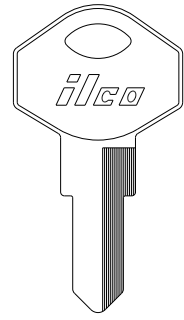

1545

—

ILCO
EZ

NORTH AMERICAN
CYLINDER

sec 2 page 48

NATIONAL LOCK HARDWARE



1064D

—

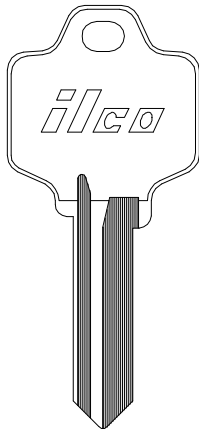

R1064D

NA6

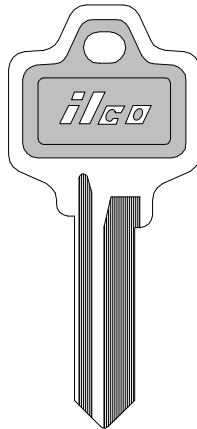

R1064E

NA25



NA25-PC

—

NORWALK

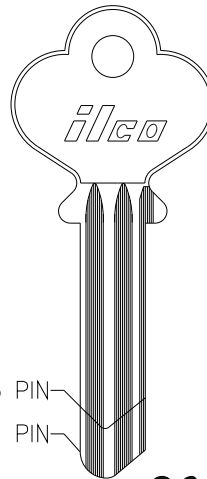

5 PIN
6 PIN

5 PIN

1017
N1

6 PIN

1017A

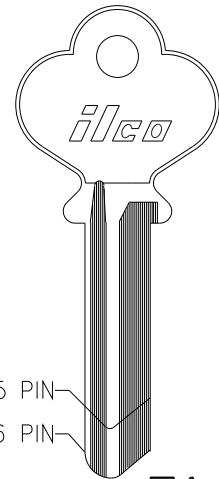

5 PIN
6 PIN

5 PIN

1017B
N3

6 PIN

1017BA

ILCO
EZ

NORWALK

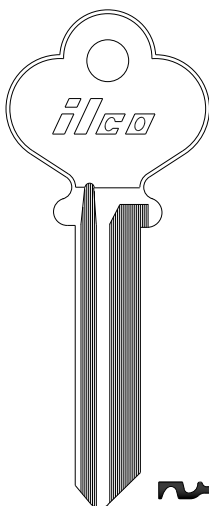

1017BB

—

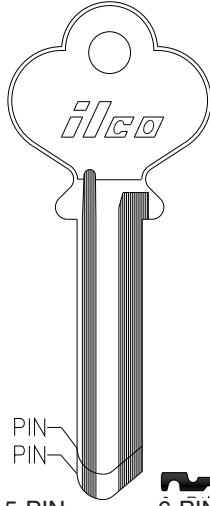

5 PIN
6 PIN

5 PIN



6 PIN

1017BL
A1017BL

—

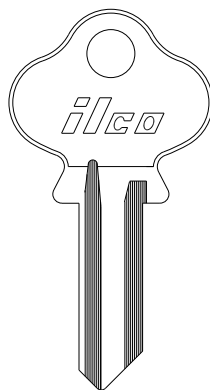

O1017B

—

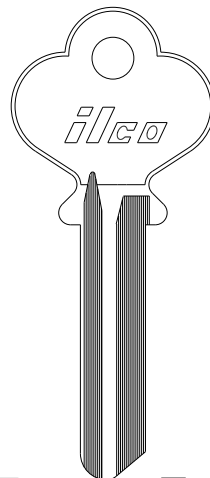

O1017ML
O1017NL

—



O1017M

—



O1017M

ILCO
EZ

NORWALK

OLYMPIC

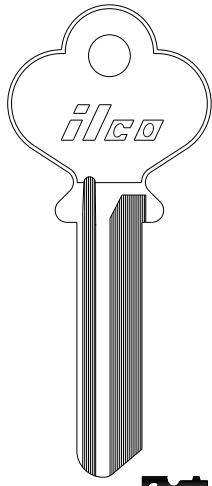

O1017WL

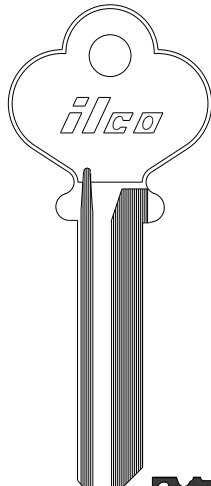

O1017NX

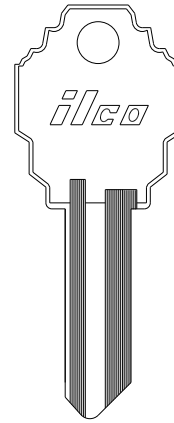

1171

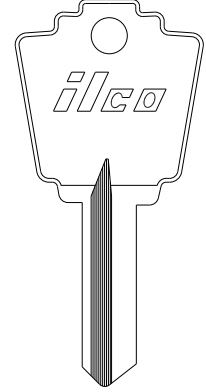

1171B

1171P
OL1

ILCO
EZ

PARKER

PENN

PETERBORO

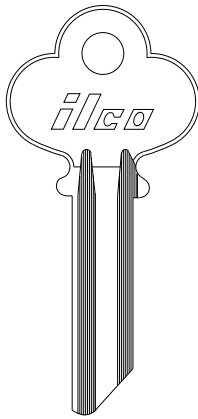

PKR1

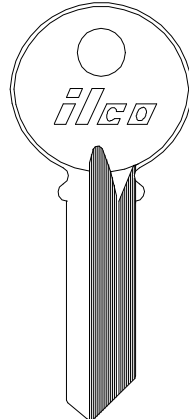

1016
P1

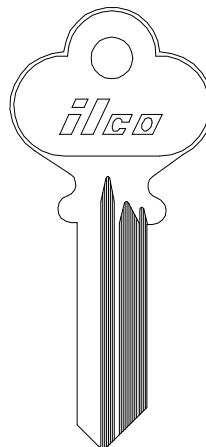

1016N
P2

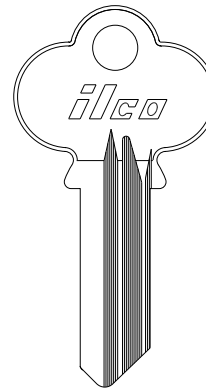

1016NB

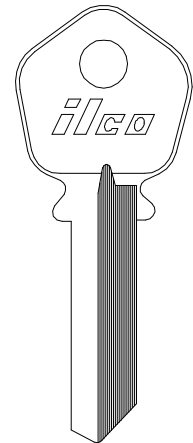

1034

ILCO
EZ

PETERBORO

PETCO

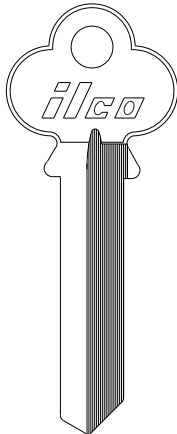

1034A

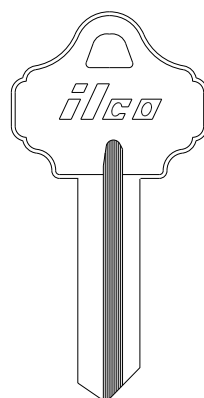

1034H

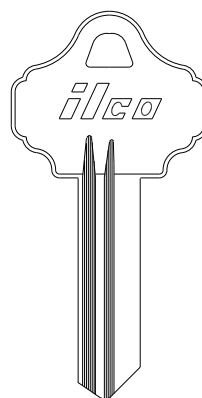

1034N

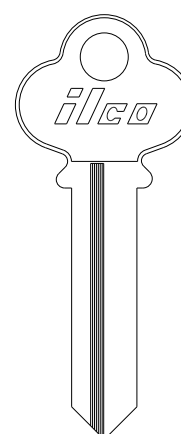

1072

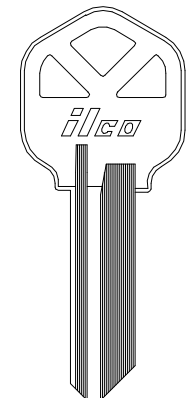

1176
KW1

ILCO
EZ

PETCO PHILLIPS

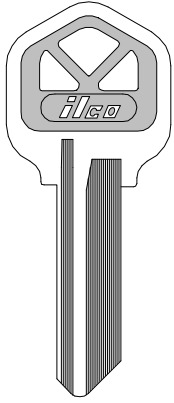

KW1-PC

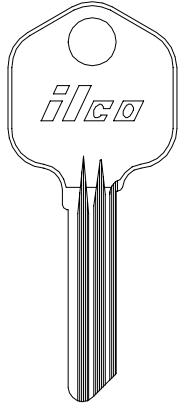

1176D

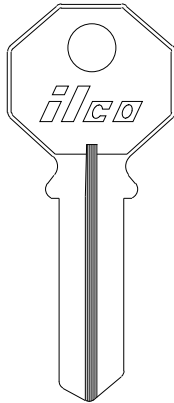

A1

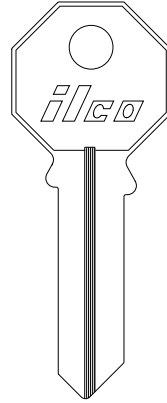

PHA1

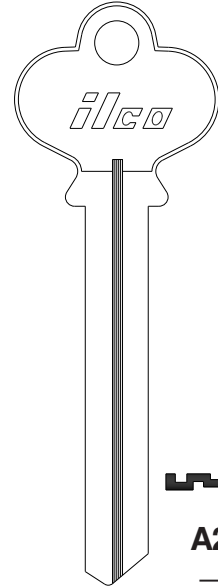

A2



ILCO
EZ

PHILLIPS PUNDRA

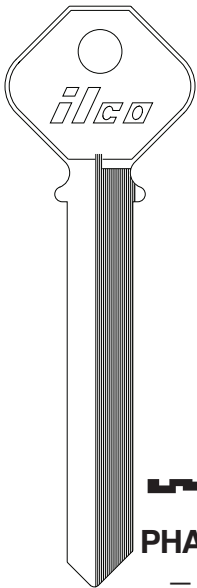

PHA2

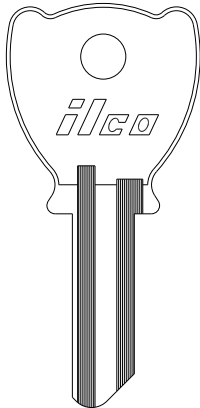

A3

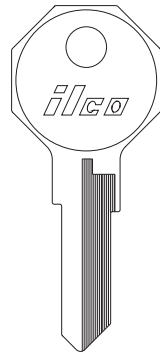

PH32

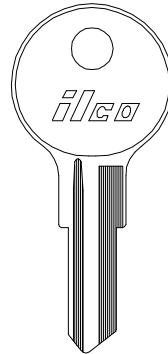

PU1



PU2



ILCO
EZ

PUNDRA

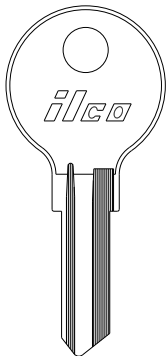

PU3

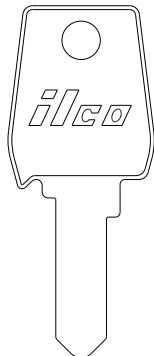

PU4

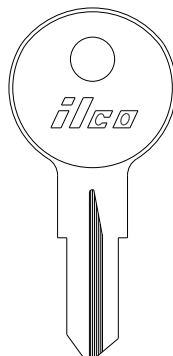

PU5



1866-4



1866-7

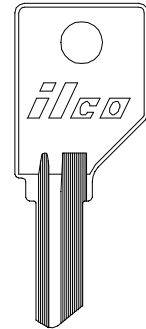

1866-10



ILCO
EZ

PUNDRRA

RAD

READING

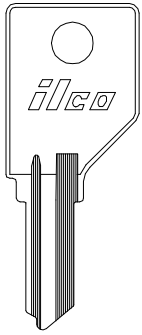

1866-13

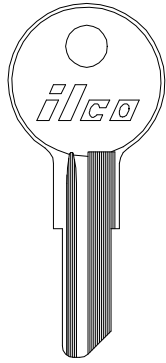

L1054B
IN8

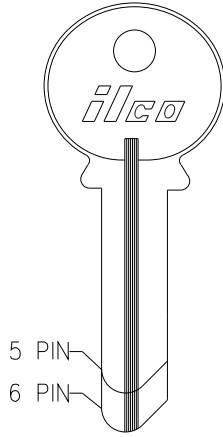

5 PIN
6 PIN



5 PIN 6 PIN
1019 1019A
RE1

5 PIN
 1019R

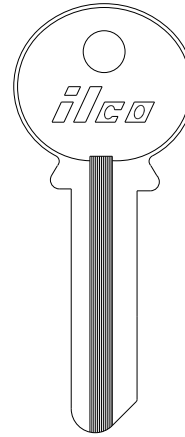

1019C

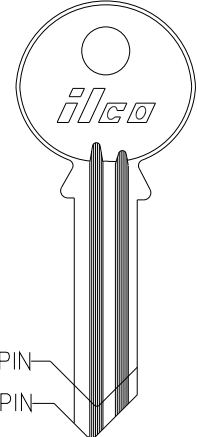

5 PIN
6 PIN



5 PIN 6 PIN
1019D 1019DA

ILCO
EZ

READING

REESE

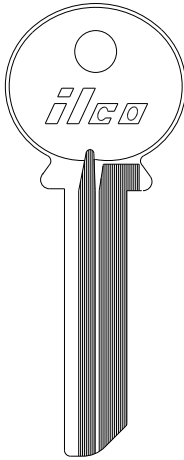

1019XL

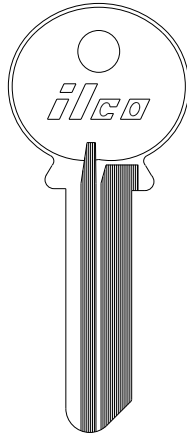

A1019M

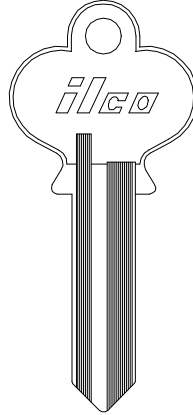

1119

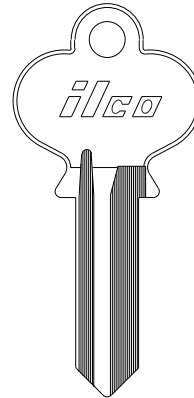

1119S

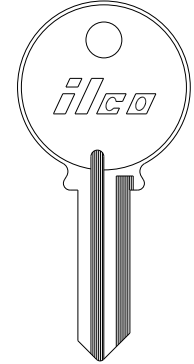

1140

ILCO
EZ

REESE

RICHILIEU

RIXSON

RUSSWIN

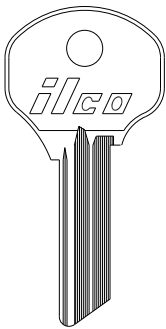

1140G
R3

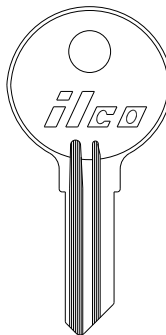

1140P

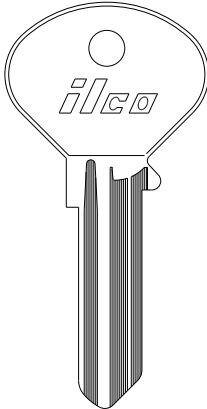

1146

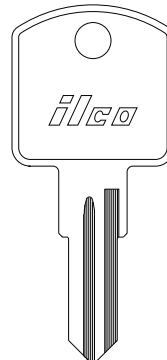

1668

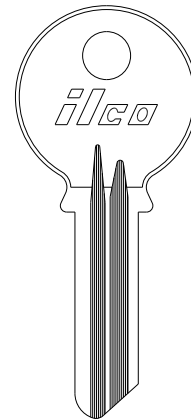

1080

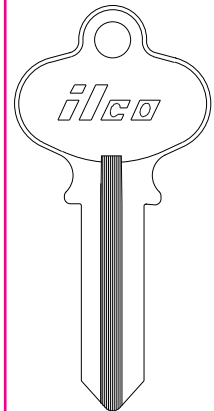

RW40R

ILCO
EZ

RUSSWIN (now Corbin/Russwin)

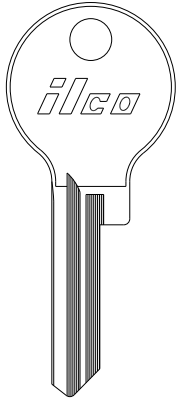

X1000KR

—

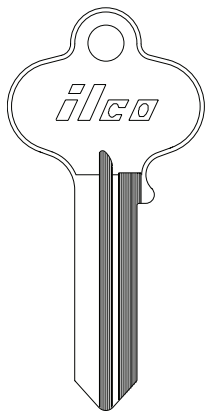

1011

RU1

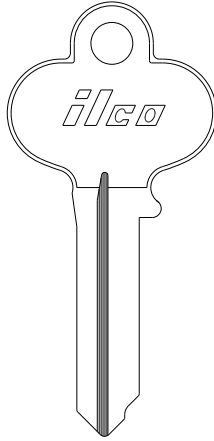

1011-04A

—

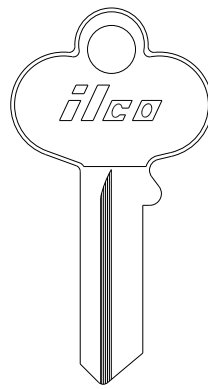

1011-04AS

—

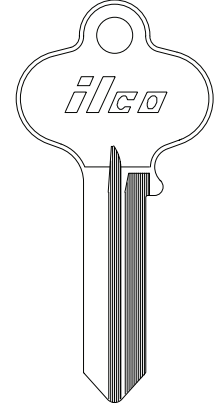

1011A

—

**ILCO
EZ**

**NORTH AMERICAN
CYLINDER**

sec 2 page 52

RUSSWIN (now Corbin/Russwin)

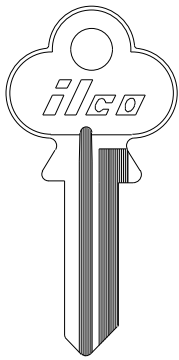

1011B

RU3

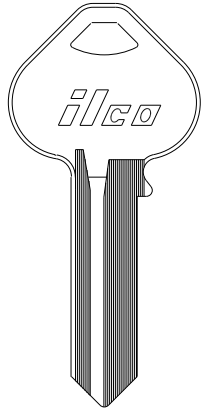

1011GH

RU44

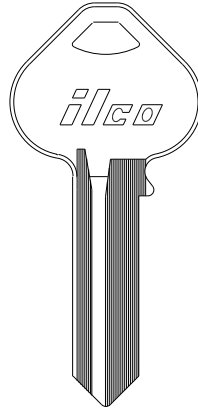

1011GJ

—

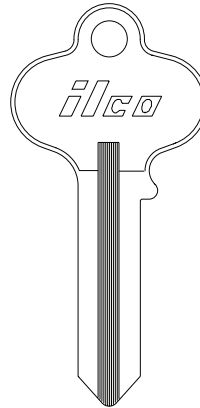

1011M

—

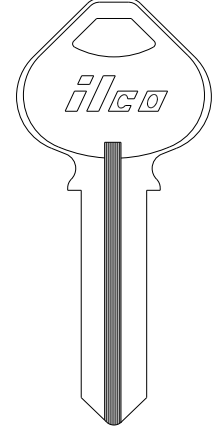

1011MA

—

**ILCO
EZ**

RUSSWIN (now Corbin/Russwin)

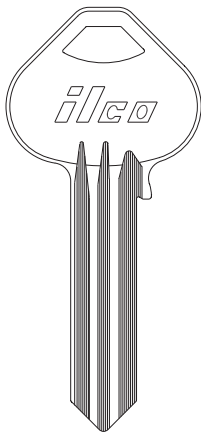

1011MK

—

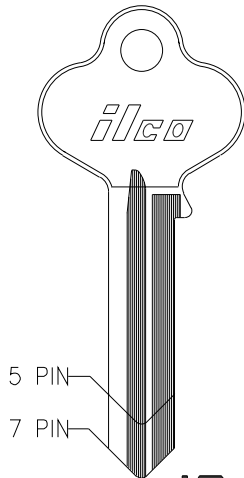

5 PIN
7 PIN

1011P
RU4



1011PAA

—

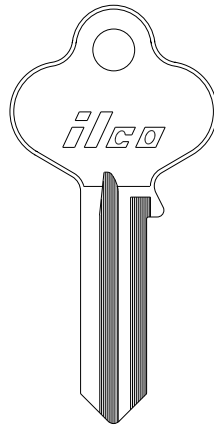

1011S

—

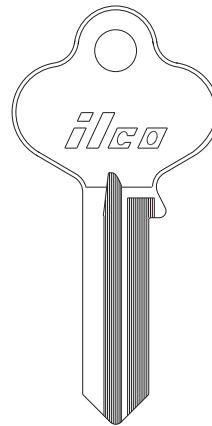

1011T

—

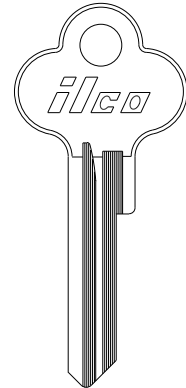

X1011KR

—



X1001KC

—

**ILCO
EZ**

ILCO
EZ

5 PIN	1011D1 RU45	1011D2 —	1011D3 —	1011D4 —
6 PIN	A1011D1 RU46	A1011D2 —	A1011D3 —	A1011D4 —
7 PIN	B1011D1 —	B1011D2 —	B1011D3 —	B1011D4 —

5 PIN	1011D12 —	1011D34 —
6 PIN	A1011D12 —	A1011D34 —
7 PIN	B1011D12 —	B1011D34 —

5 PIN	1011D41 —
6 PIN	A1011D41 RU53
7 PIN	B1011D41 —

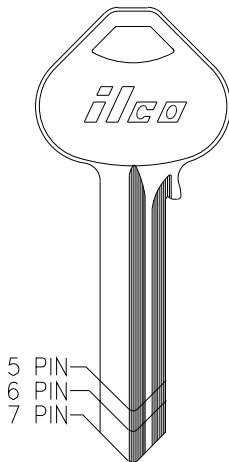

5 PIN	1011-L1 —	1011-L2 —	1011-L3 —	1011-L4 —
6 PIN	A1011-L1 —	A1011-L2 —	A1011-L3 —	A1011-L4 RU101
7 PIN	L1011-L1 —	L1011-L2 —	L1011-L3 —	L1011-L4 —

5 PIN	1011-L12 —	1011-L34 —
6 PIN	A1011-L12 —	A1011-L34 —
7 PIN	L1011-L12 —	L1011-L34 —

5 PIN	1011-L41 —
6 PIN	A1011-L41 —
7 PIN	L1011-L41 —

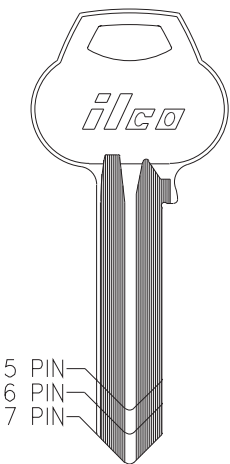

RUSSWIN (now Corbin / Russwin)

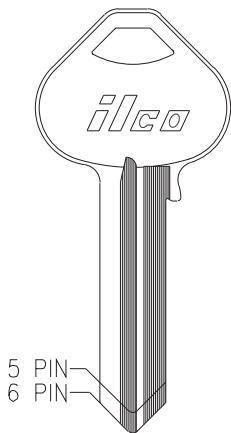

5 PIN	N1011P RU52	N1011S —	N1011T —
6 PIN	A1011P RU16	A1011S —	A1011T —
5 PIN	N1011M RU7		
6 PIN	A1011M —		

ILCO
EZ

NORTH AMERICAN
CYLINDER

sec 2 page 55

RUSSWIN (now Corbin / Russwin)

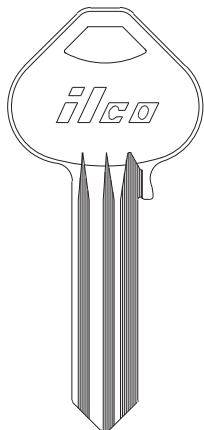

	A1011H1 —	A1011H6 —
	A1011H2 —	A1011H7 —
	A1011H3 —	A1011H8 —
	A1011H5 —	

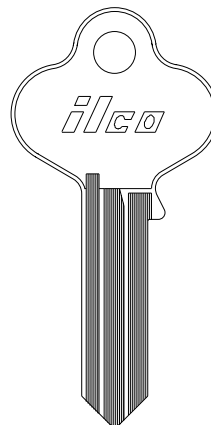

	1011PH —
	1011PM —
	(MASTER) 1011PZ —

ILCO
EZ

RUSSWIN (now Corbin / Russwin)

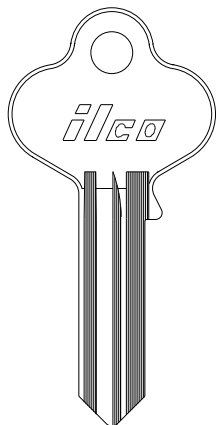

	1011K1 —	1011K5 —	1011K9 —	1011K13 —
	1011K2 —	1011K6 —	1011K10 —	
	1011K3 —	1011K7 —	1011K11 —	
	1011K4 —	1011K8 —	1011K12 —	

ILCO
EZ

RUSSWIN (now Corbin / Russwin)

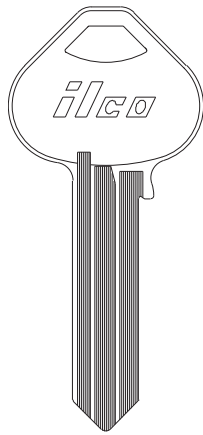

	A1011-1N	A1011-5N	A1011-9N	A1011-13N
	-	-	-	-
	A1011-2N	A1011-6N	A1011-10N	A1011-14N
	-	-	-	-
	A1011-3N	A1011-7N	A1011-11N	
	-	-	-	
	A1011-4N	A1011-8N	A1011-12N	
	-	-	-	

(MASTER)
A1011PZ

**ILCO
EZ**

**NORTH AMERICAN
CYLINDER**

sec 2 page 56

RUSSWIN (now Corbin / Russwin)

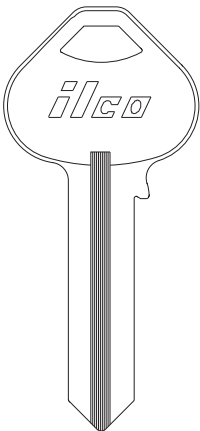

	A1011-15N	A1011-19N	A1011-23N	A1011-27N
	-	-	-	-
	A1011-16N	A1011-20N	A1011-24N	A1011-28N
	-	-	-	-
	A1011-17N	A1011-21N	A1011-25N	
	-	-	-	
	A1011-18N	A1011-22N	A1011-26N	
	-	-	-	

(MASTER)
A1011PZR

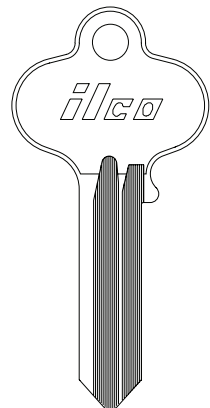

**1012
RU2**

**ILCO
EZ**

RUSSWIN (now Corbin/Russwin)

SAFE

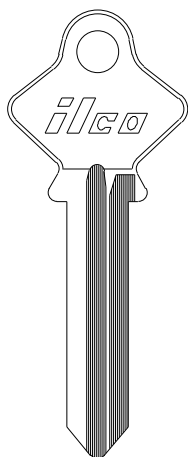

1012A

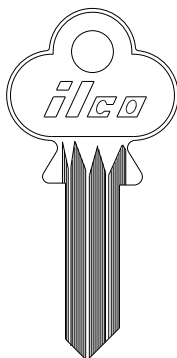

1012DM

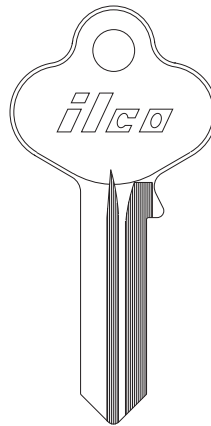

1011-28N

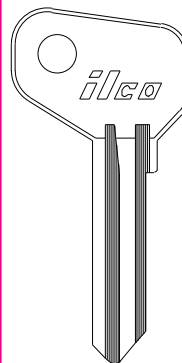

SF10

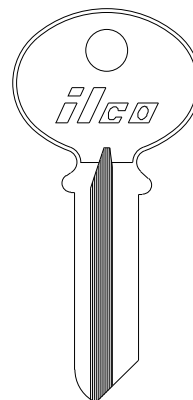

1049D

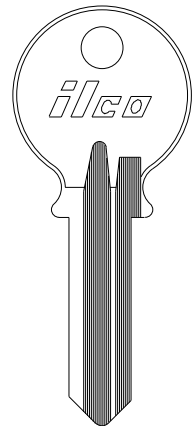

1049E

**ILCO
EZ**

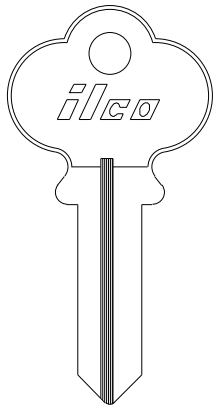
SAGER**1047**

—

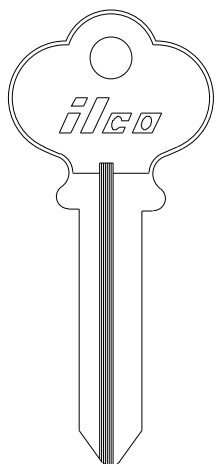
**1047A**

—

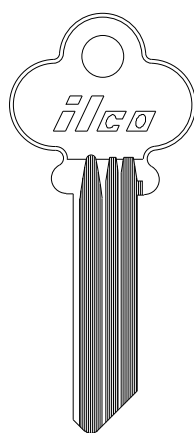
**1047CL**

—

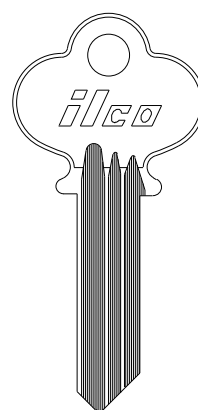
**1047CR**

SA1

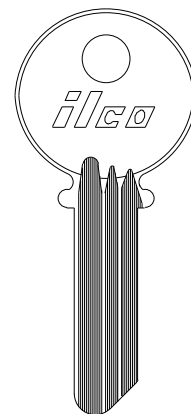
**1047M**

—

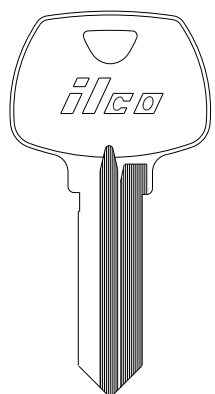
ILCO
EZ**SARGENT****1007**

—

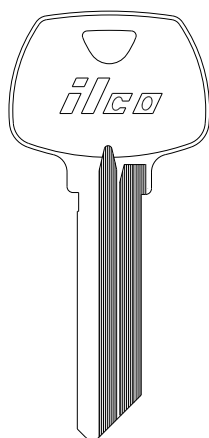
**A1007**

—

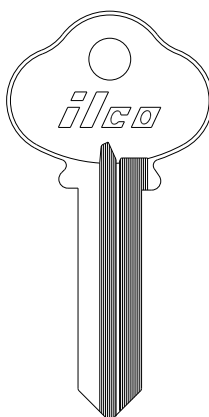
**1007A**

—

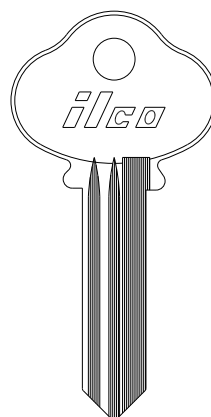
**1007G**

—

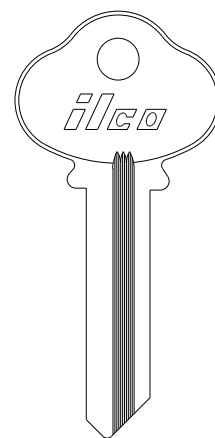
**1007KM**

—

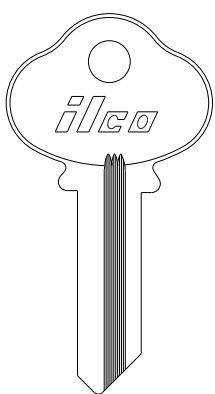
ILCO
EZ**SARGENT****O1007KM**

—

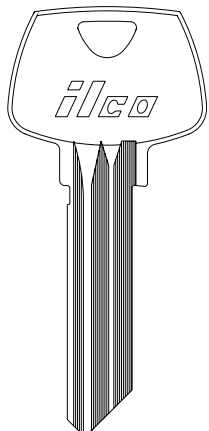
**O1007CR**

—

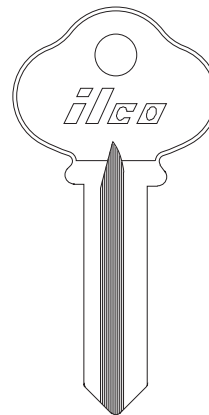
**O1007JA**

—

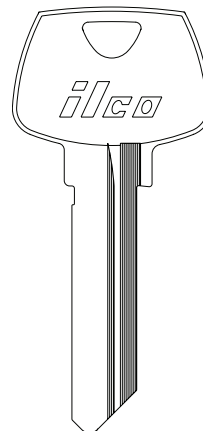
**O1007NB**

—

ILCO
EZ

SARGENT

5 PIN	1007ca S22½	1007CB —	1007CC —	1007CE —	1007CF —	1007CG —	1007CJ —	1007CK —	1007CL —
6 PIN	O1007CA S22	O1007CB —	O1007CC —	O1007CE —	O1007CF —	O1007CG —	O1007CJ —	O1007CK —	O1007CL —
7 PIN	L1007CA —	L1007CB —	L1007CC —	L1007CE —	L1007CF —	L1007CG —	L1007CJ —	L1007CK —	L1007CL —

ILCO
EZ

NORTH AMERICAN
CYLINDER

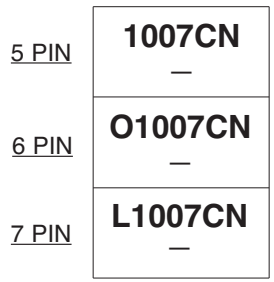
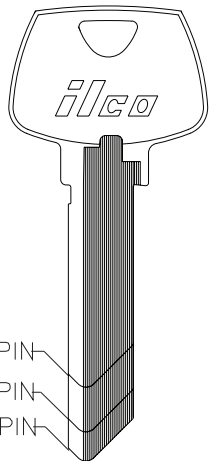
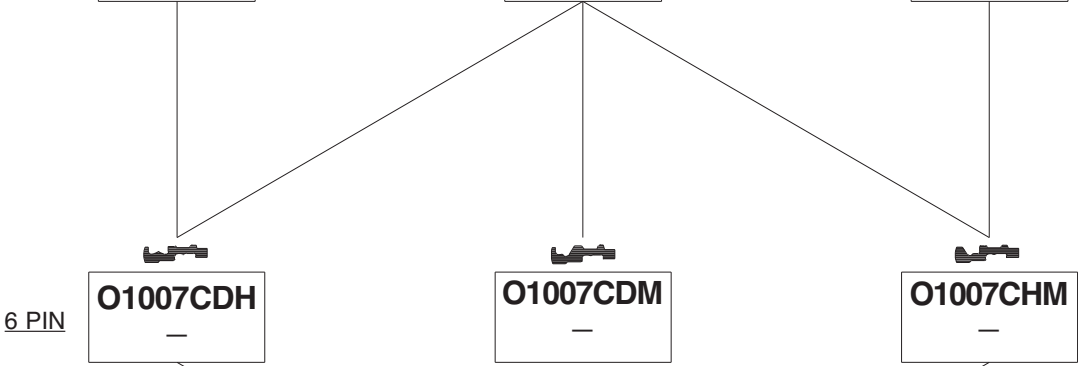
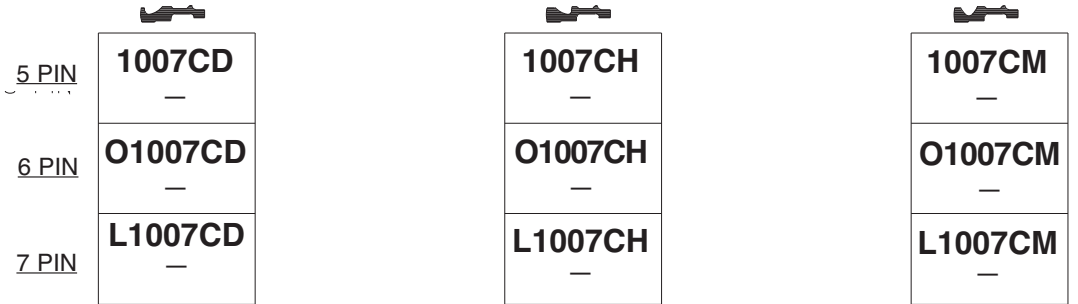

SARGENT

5 PIN	1007HA —	1007HB —	1007HC —	1007HE —	1007HF —	1007HG —	1007HJ —	1007HK —	1007HL —
6 PIN	O1007HA —	O1007HB —	O1007HC —	O1007HE —	O1007HF —	O1007HG —	O1007HJ —	O1007HK —	O1007HL —

5 PIN	1007HD —
6 PIN	O1007HD —

5 PIN	1007HH —
6 PIN	O1007HH —

5 PIN	1007HM —
6 PIN	O1007HM —

5 PIN	1007HDH —
6 PIN	O1007HDH —

5 PIN	1007HN —
6 PIN	O1007HN —

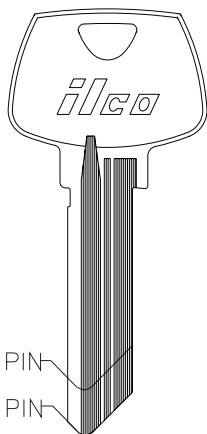

ILCO
EZ

NORTH AMERICAN
CYLINDER

SARGENT

NORTH AMERICAN
CYLINDER

ILCO
EZ

5 PIN	1007LA —	1007LB —	1007LC —	1007LE —	1007LF —	1007LG —	1007LJ —	1007LK —	1007LL —
6 PIN	O1007LA —	O1007LB —	O1007LC —	O1007LE —	O1007LF —	O1007LG —	O1007LJ —	O1007LK —	O1007LL —
7 PIN	L1007LA —	L1007LB —	L1007LC —	L1007LE —	L1007LF —	L1007LG —	L1007LJ —	L1007LK —	L1007LL —

5 PIN

	1007LD —
6 PIN	O1007LD —
7 PIN	L1007LD —

5 PIN

	1007LH —
6 PIN	O1007LH —
7 PIN	L1007LH —

5 PIN

	1007LM —
6 PIN	O1007LM —
7 PIN	L1007LM —

5 PIN

	1007LDH —
6 PIN	O1007LDH —

5 PIN

	1007LDM —
6 PIN	O1007LDM —

5 PIN

	1007LHM —
6 PIN	O1007LHM —

6 PIN

5 PIN

	N1007KMB —
6 PIN	N1007KMA —
7 PIN	N1007KMC —

6 PIN

7 PIN

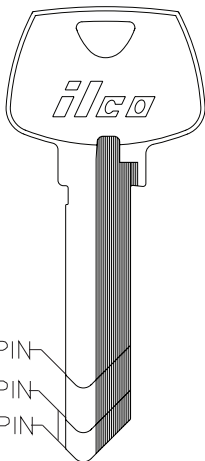

5 PIN

6 PIN

7 PIN

SARGENT

5 PIN	1007RA —	1007RB —	1007RC —	1007RE —	1007RF —	1007RG —	1007RJ —	1007RK —	1007RL —
6 PIN	O1007RA —	O1007RB —	O1007RC —	O1007RE —	O1007RF —	O1007RG —	O1007RJ —	O1007RK —	O1007RL —

ILCO
EZ

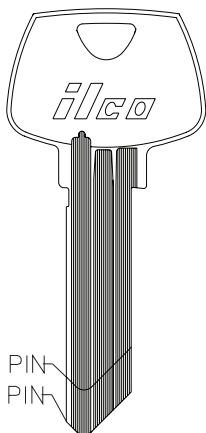
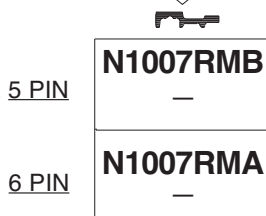
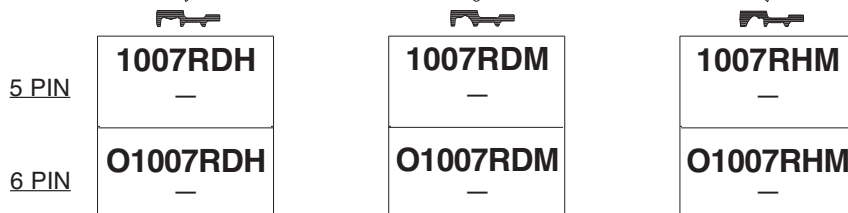
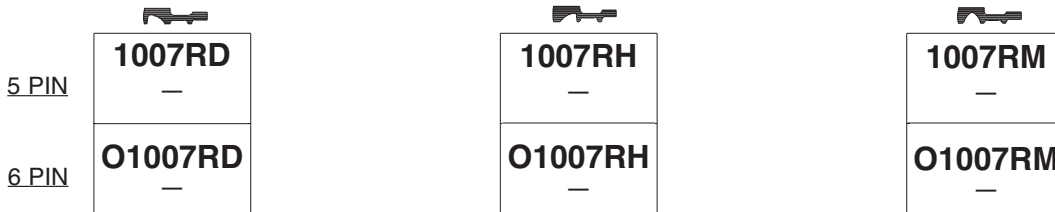

5 PIN
6 PIN

SARGENT

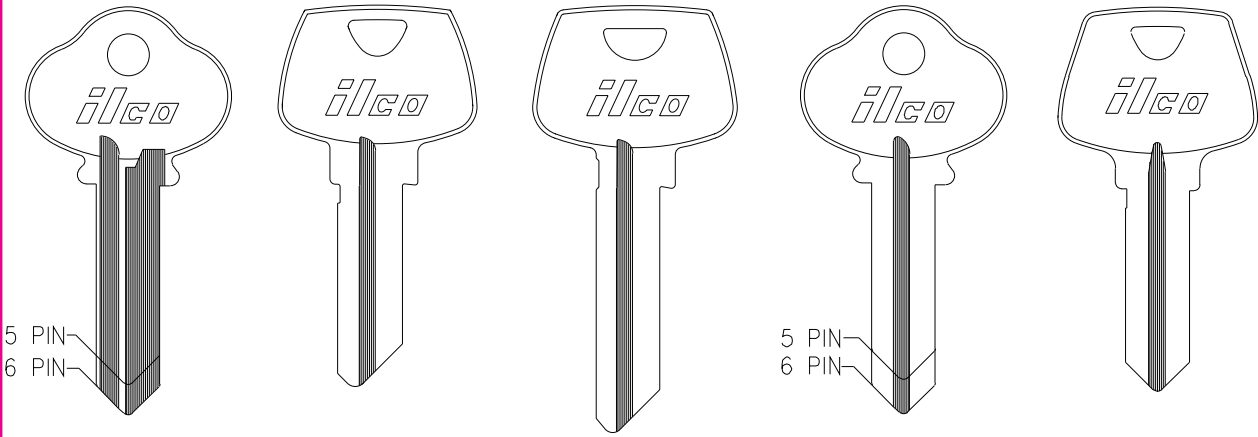

						
5 PIN	6 PIN			5 PIN	6 PIN	
1008	1008A	A1008	A1008A	1009	1009A	1009M
—	—	—	—	S1	S5	—

ILCO
EZ

NORTH AMERICAN
CYLINDER

sec 2 page 62

SARGENT

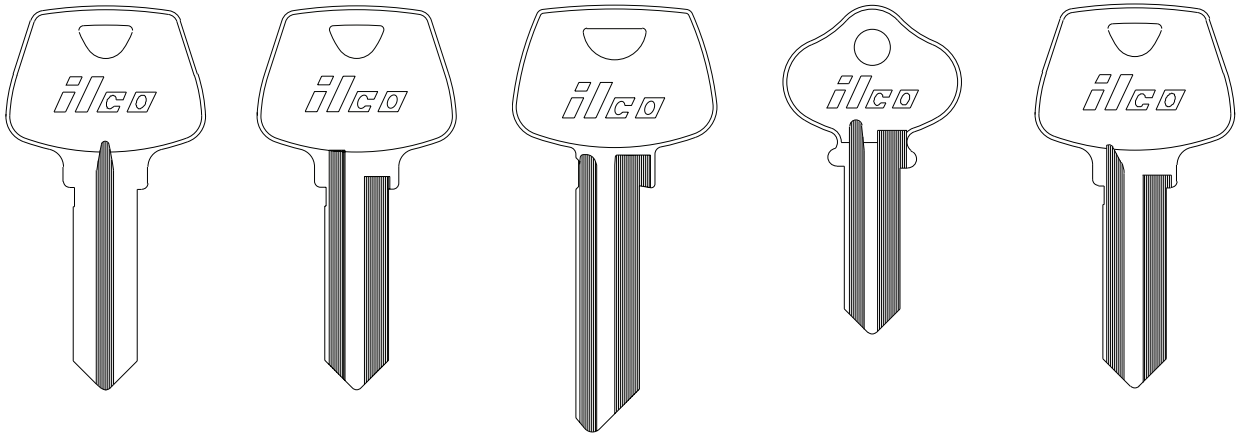

					
O1009	1010	1010A	1010B	S1010B	1010M
S2	S3	—	S10	—	—

ILCO
EZ

SARGENT

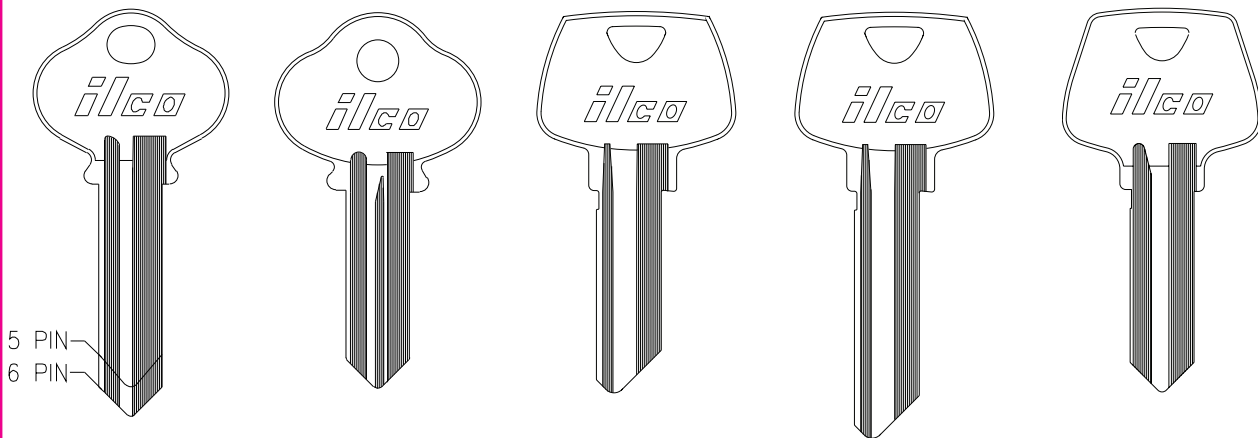

					
5 PIN	6 PIN				
1010S	1010SA	1010T	1010N	L1010N	1010U
—	—	—	S68	—	—

ILCO
EZ

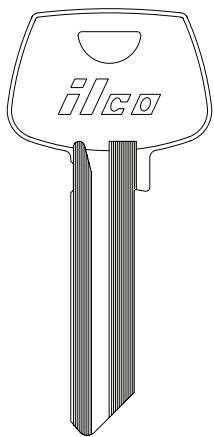
SARGENT

A1010U

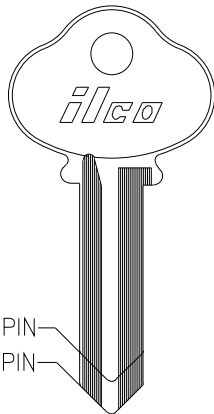

5 PIN
6 PIN

O1010 **O1010A**

S4

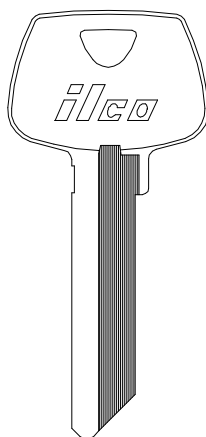

S6

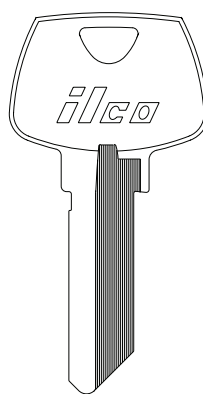

S16

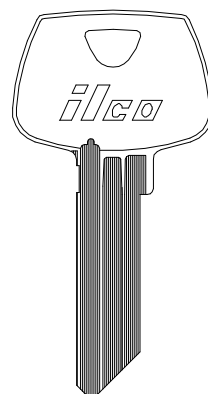

S32

ILCO
EZ

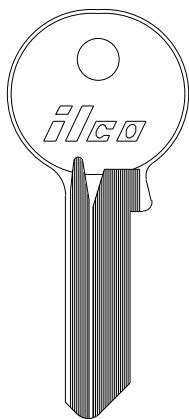
SARGENT

O1054

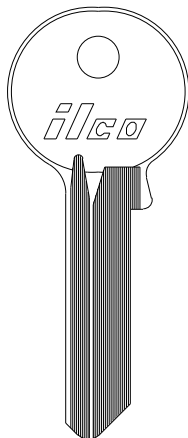

O1054A

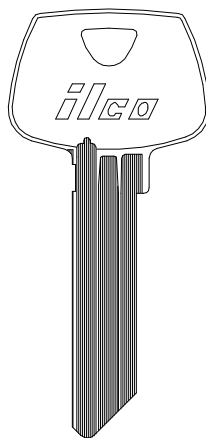

S31

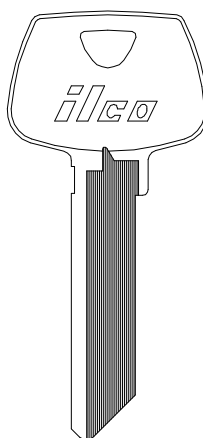

S70

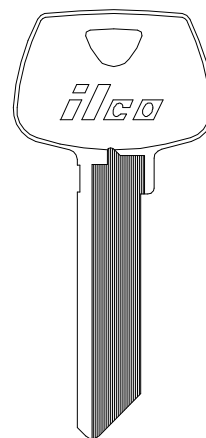

S73

ILCO
EZ

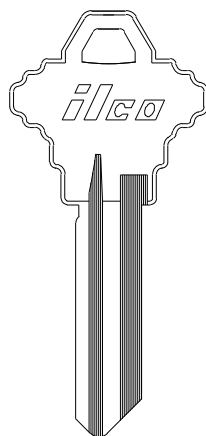
SCHLAGE

SC1246

SC1247

SC1248

SC1345

SC1347

SC1348

SC1368

SC1400

SC1456

SC1460

SC1467

SC1468

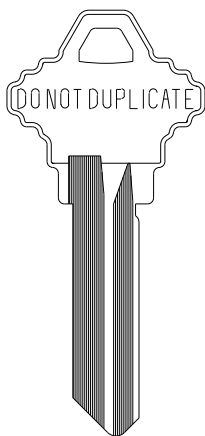

101C-NS-DND

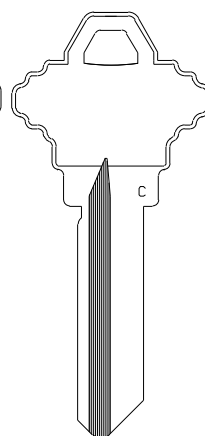

101C-NS-PLAIN

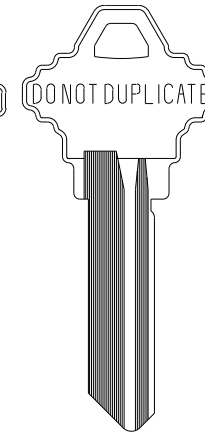

101E-NS-DND

ILCO
EZ

SCHLAGE



5 PIN	1145 SC1	1145CE —	1145E SC8	1145EF —	1145F SC7	1145FG —	1145G —
6 PIN	1145A SC4	A1145CE —	A1145E SC9	A1145EF —	A1145F SC10	A1145FG —	A1145G —

NORTH AMERICAN CYLINDER

ILCO EZ

sec 2 page 64

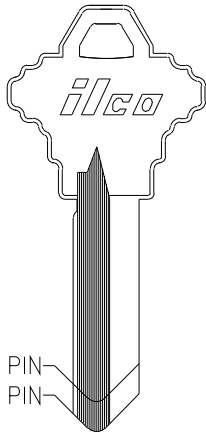

5 PIN	1145H —
6 PIN	A1145H SC15

5 PIN	1145J —
6 PIN	A1145J —

5 PIN	1145K —
6 PIN	A1145K —

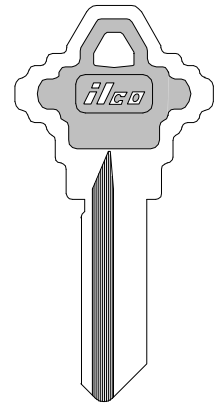

5 PIN	1145L SC19
6 PIN	A1145L SC20



SC1-PC
—

ILCO EZ

SCHLAGE

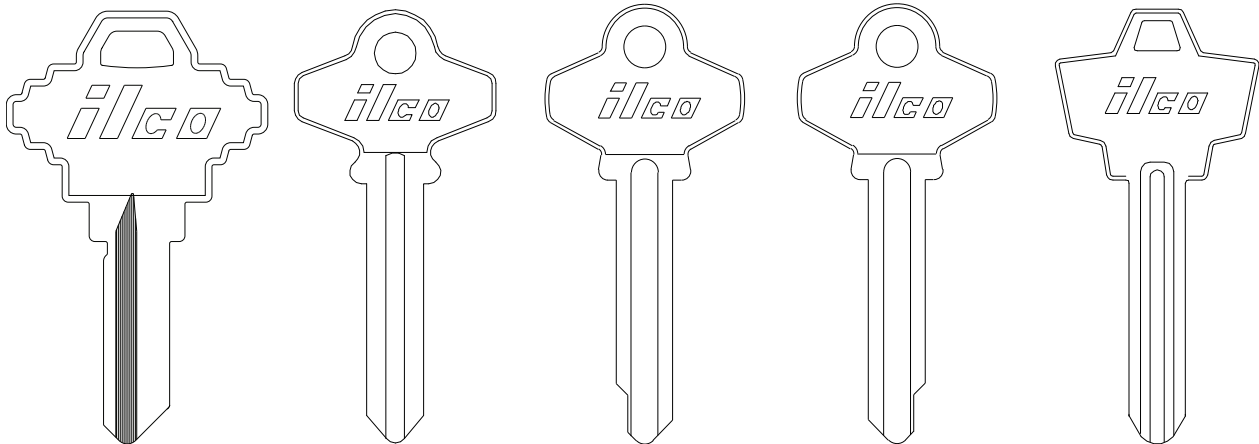

SC1-BIG
—

1307A
SC6

L1307A
—

R1307A
—

1307W
SC22

ILCO EZ

SCHLAGE

SCHROEDER

SCHROEDER THOMPSON

SECURITY

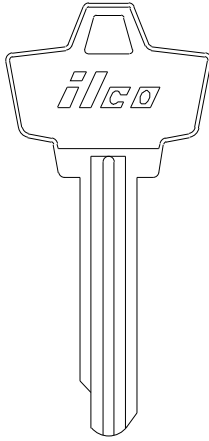

L1307W

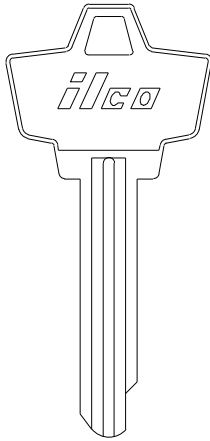

R1307W

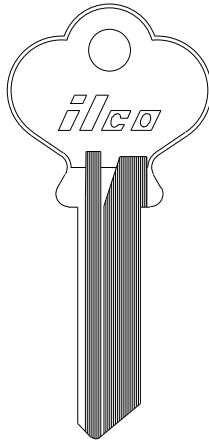

(MASTER)
1126M



759ST

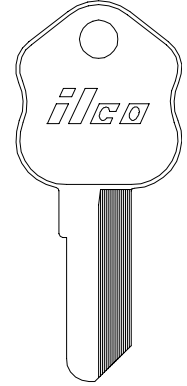

SY9

ILCO
EZ

SECURITY

SECURITY MAILBOX

SEGAL

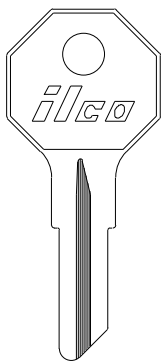

SC1098X

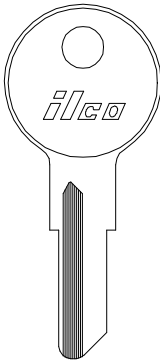

O1122B
Y103

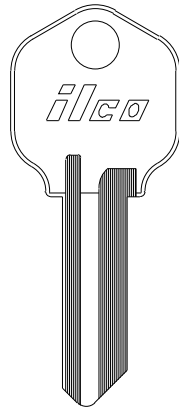

SC1176

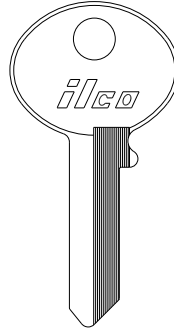

1559

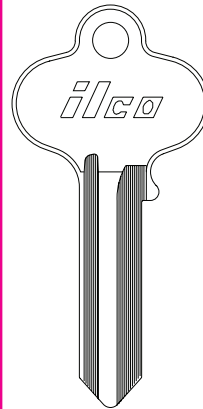

1022
SE1



O1022
SE2

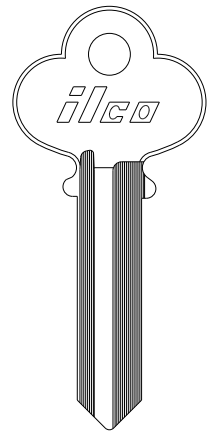

1022AB



O1022AB

ILCO
EZ

SEGAL

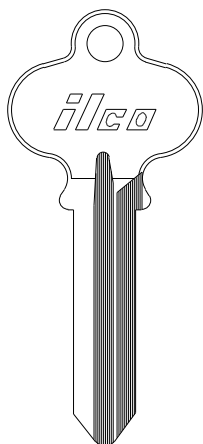

1022H

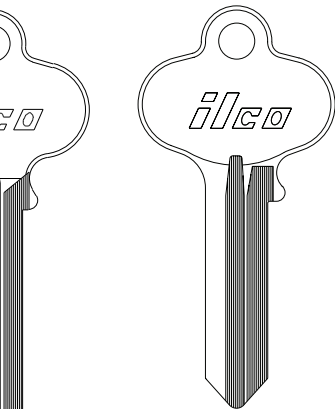

1022HR

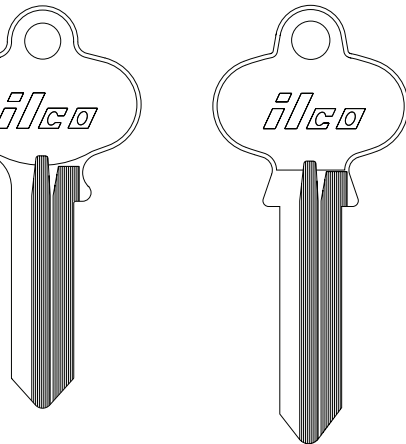

1022L

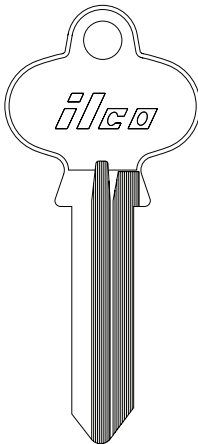

R1022L

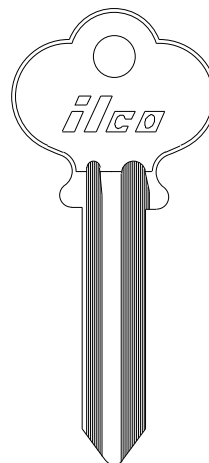

O1022A

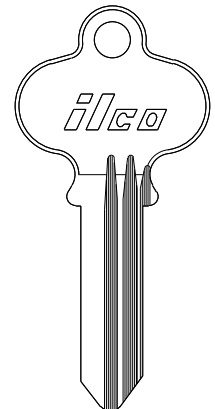

O1022E

ILCO
EZ

SENTRY SAFES		SHAW WALKER		SKILLMAN	SKYTRAK
1626 SS4	1637 SS5	1534 —	1568 —	R1001EN SK1	1642 —

ILCO
EZ

SLAYMAKER					
SLA14 —	SLA15 —	SLA16 —	1074E —	A1074E —	1074B —
		SLA17 —	1074F —	A1074F —	1074N —
		S1073DF —	1074G —	A1074G —	1074A —
		1073DF —	1074N —	1074B —	A1074B —

ILCO
EZ

SLAYMAKER					SOLON
1074BM —	1120K —	1120D SL1	1120F SL20	1120J —	1120S —
			1120G —	1120N —	S42 —
			1120H —		

ILCO
EZ

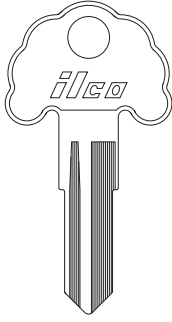
SOUTHERN IMPERIAL SUN
STANLEY PADLOCK
TAYLOR

1624

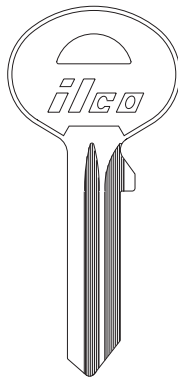
—

1636

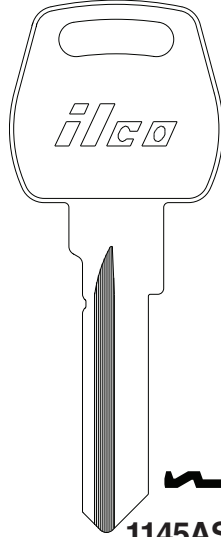
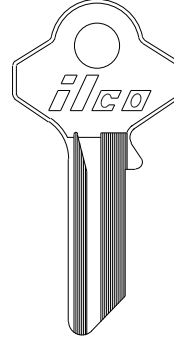
—

**1145AST
ST4**

TY1

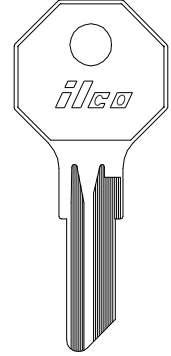
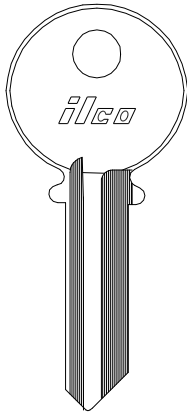
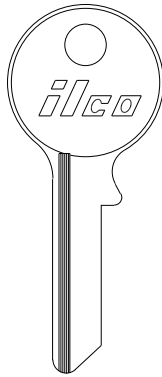
—

**H1122M
T2**
**ILCO
EZ**
TAYLOR

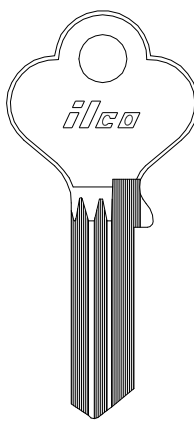
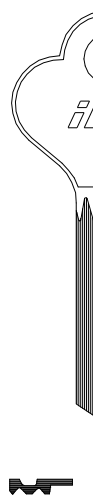
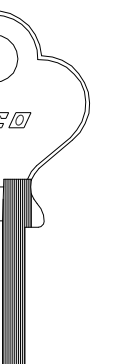
**1141
T1**

1141E

—

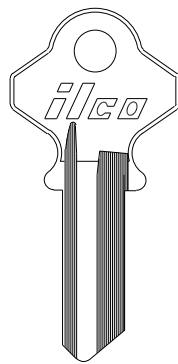
**1141F
T3**

**1141GE
T7**

1141GS

—

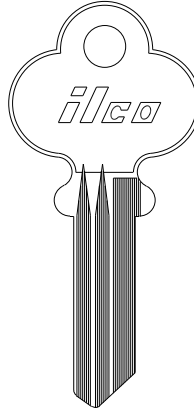
1141H

—

1141JE

—

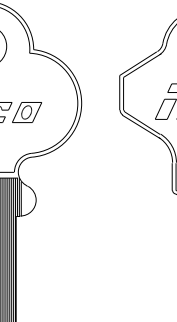
1141JL

—

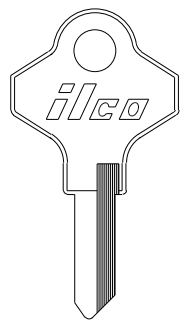
1141K

—

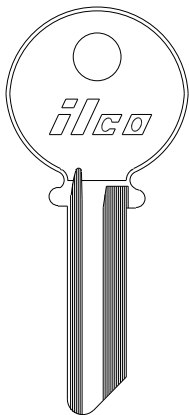
**ILCO
EZ**
TAYLOR
TEGCO
**THERMOSTAT
BOX**
TIMBERLINE

1141L

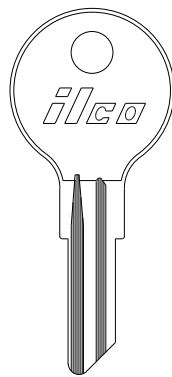
—

1141W

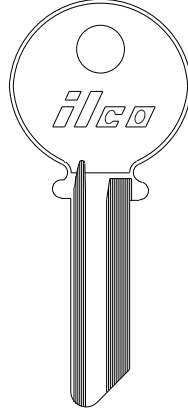
—

TG1

—

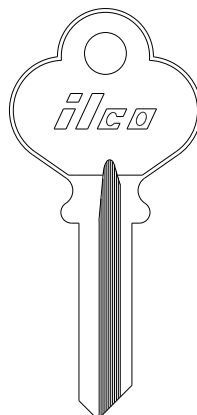
1013BF

—

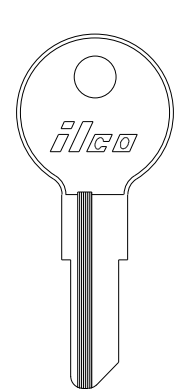

1541

—

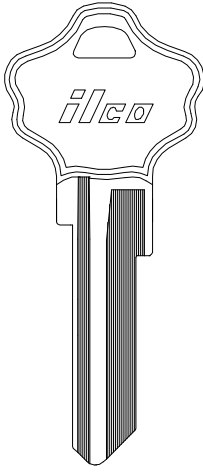

**1043J
IL11**
**ILCO
EZ**

TITAN / KWIKSET

TRIMARK

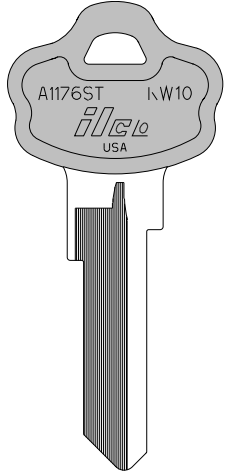

A1176ST
KW10



KW10-PC
—

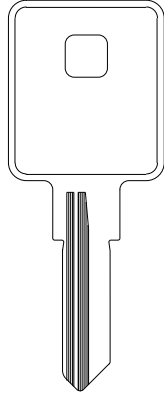

1601
TM1

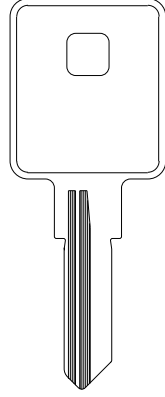

1602
TM2

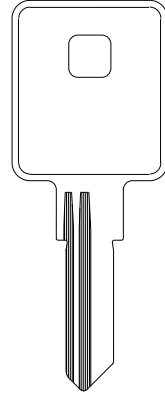

1603
TM3

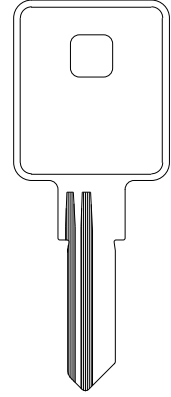

1604
TM4

ILCO
EZ

TRIMARK

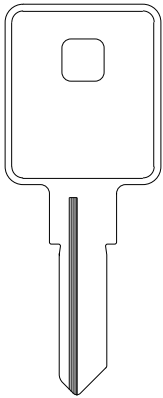

1606
TM6

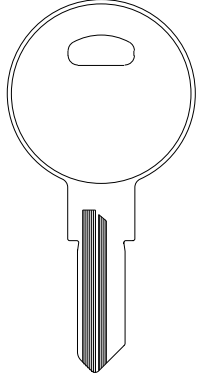

1607
TM7

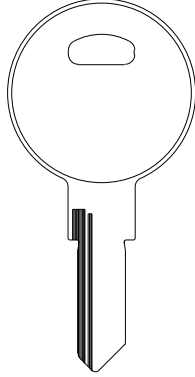

1608
TM8

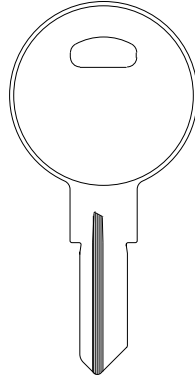

1609
TM9

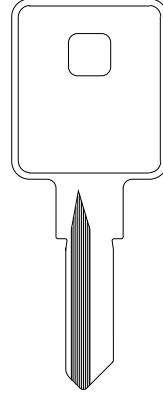

1610
TM10

ILCO
EZ

TRIMARK

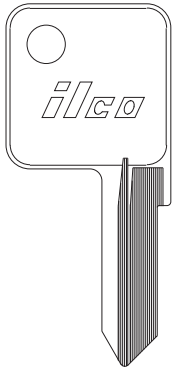

1612
TM12

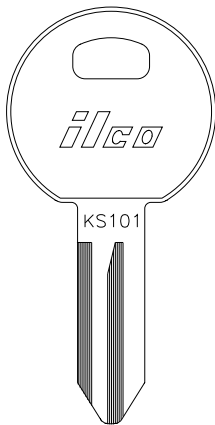

1621
TM13

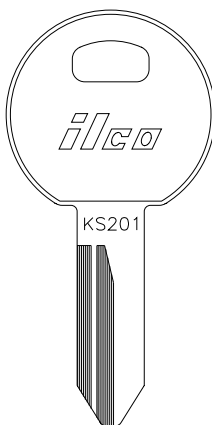

1622
TM14

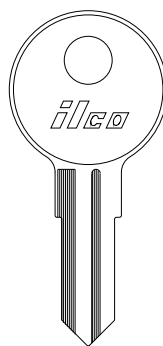

1623
TM15

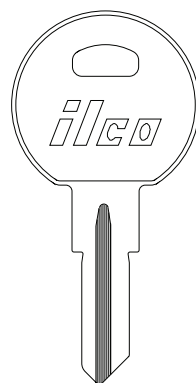

1650
TM16

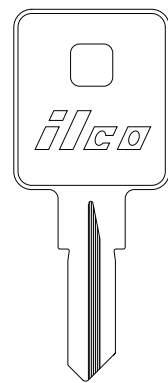

1651
TM17

ILCO
EZ

TRIMARK

UNICAN

USPS

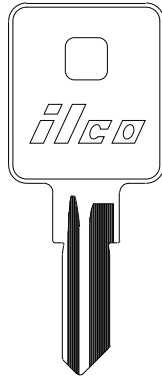
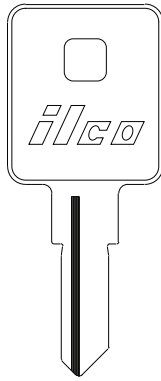
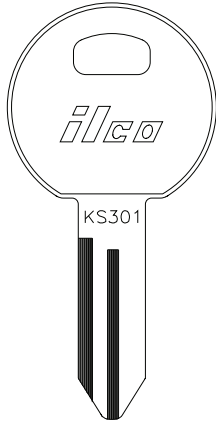

SEE
ILCO

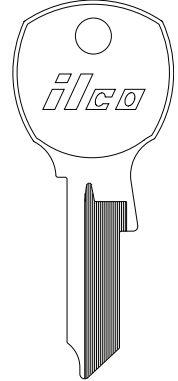
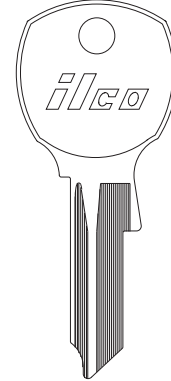

ILCO
EZ

1665
TM18

1666
TM19

1667
TM20

1646
—

1646R
—

VIMCAR

WEISER

SEE
OLYMPIC

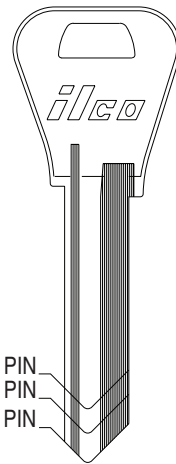
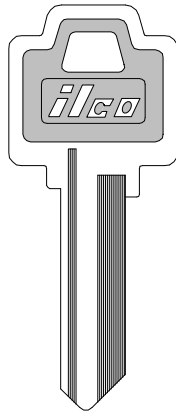
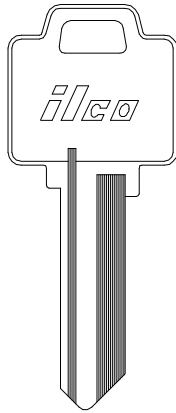

6 PIN
A1054WB
WR4

7 PIN
L1054WB
—

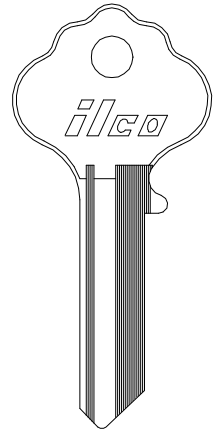

ILCO
EZ

N1054WB
WR5

WR5-PC
—

5 PIN
1054WB
WR3

X1054WA
WR2

WELCH

WESLOCK

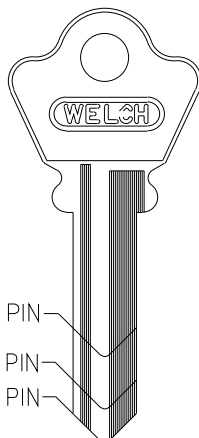
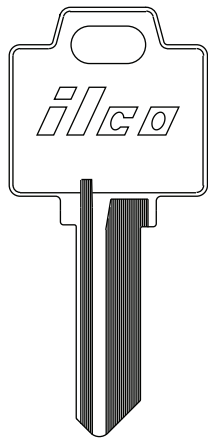

5 PIN
1123
WE1

6 PIN
1123A
—

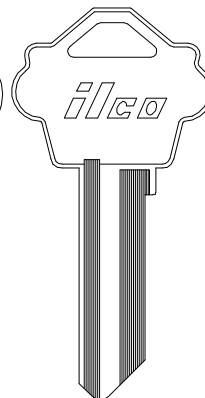
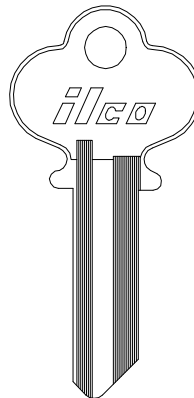

ILCO
EZ

N1176
WR6

4 PIN
1123S
—

1175
WK1

1175N
WK2

WESLOCK WILSON-BOHANNON

 WK2-PC -	 WB19 -	 4 PIN 1071B -	<p>5 PIN 1071 W1</p> <p>6 PIN 1071A -</p>	 1071AB -
----------------------------	--------------------------	------------------------------------	---	----------------------------

ILCO
EZ

WILSON-BOHANNON WIND WINFIELD WISE PADLOCK

 4 PIN 1071BD -	 5 PIN 1071D -	 1634 WN1	 1071E -	 1071M -
-------------------------------------	------------------------------------	----------------------------	---------------------------	---------------------------

ILCO
EZ

WRIGHT PRODUCTS XL LOCK YALE

 1616 WTP1	 1662 WTP2	 1180S XL7	 1182 -	 1 -	 1N -
-----------------------------	-----------------------------	-----------------------------	--------------------------	-----------------------	------------------------

ILCO
EZ

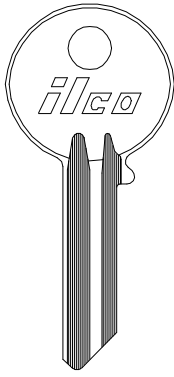
YALE

YL1
—

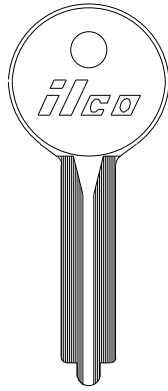

2N
—



YL5
—

O997A
—

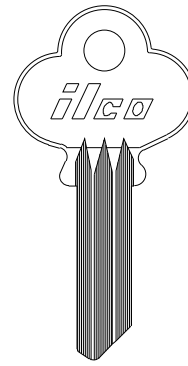

Y8
—

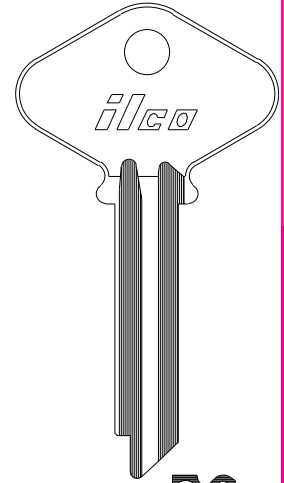

D9
—

ILCO
EZ

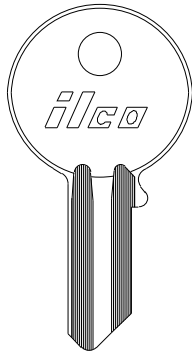
YALE

SX9B
—

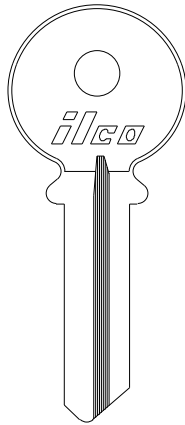

Y9E
—

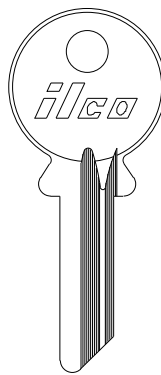

Y204
—

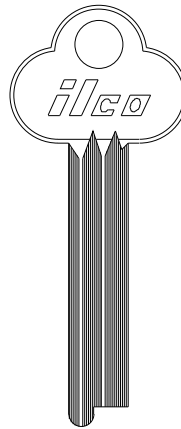

889A
—

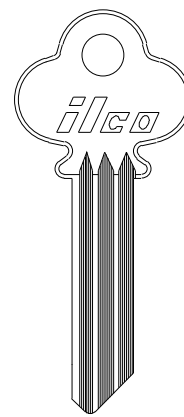

994ARM
—

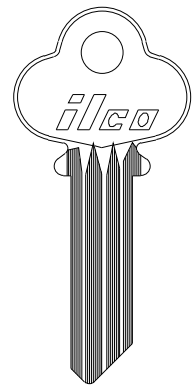

994M
—

ILCO
EZ

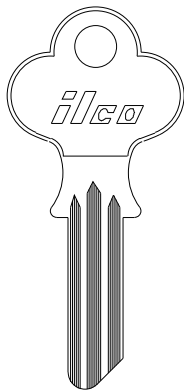
YALE

996M
—

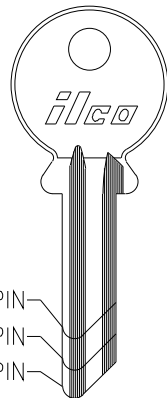

4 PIN
997B
—

5 PIN
Y200
—

6 PIN
997A
—

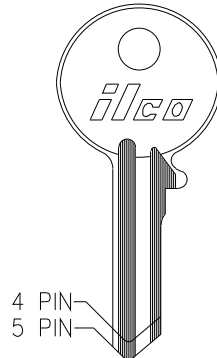

4 PIN **5 PIN**
997DB **997D**
—

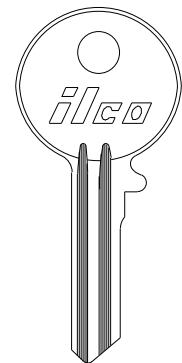

997DA **R997DA**
Y34 —

ILCO
EZ

YALE

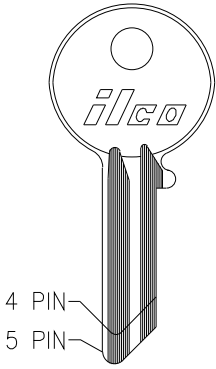

4 PIN
5 PIN

4 PIN 5 PIN

997EB **997E**
Y5 Y52

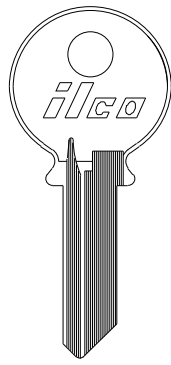

997G **997GR**

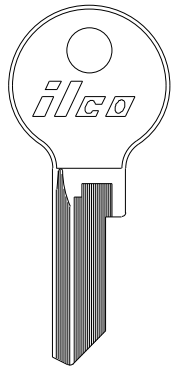

997GX **997GXR**

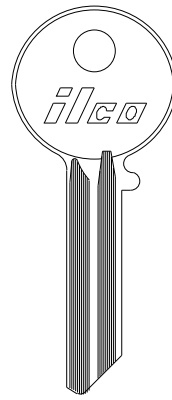

997JA
—



997JB

—



997JC

—



997JD

—



997JF

—



997JG

—



997JH

—



997JK
—

ILCO
EZ

NORTH AMERICAN
CYLINDER

sec 2 page 72

YALE

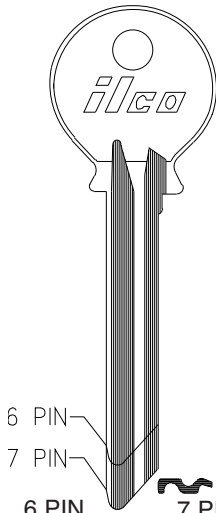

6 PIN
7 PIN

6 PIN 7 PIN
997L **997LA**

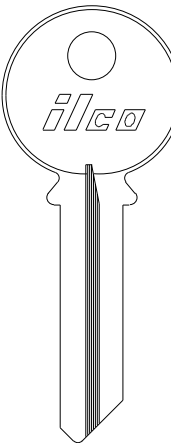

997PA

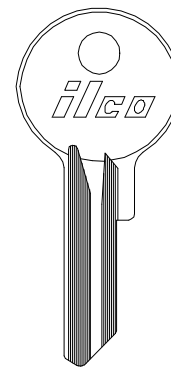

997X
Y6

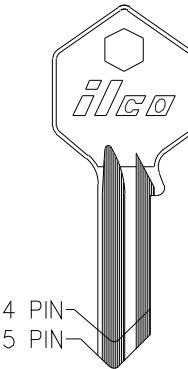

4 PIN
5 PIN

4 PIN 5 PIN
H997EB **H997E**

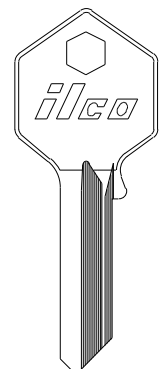

H997ER

ILCO
EZ

YALE

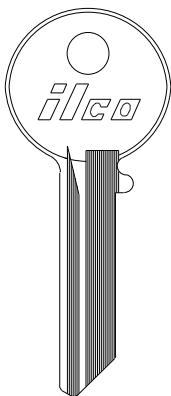

J997M **J997MR**
— —

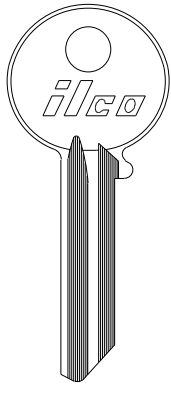

A997EH
—

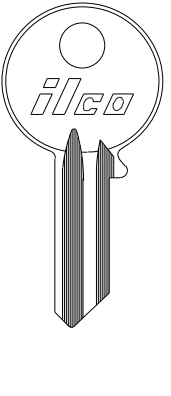

B997EH
—

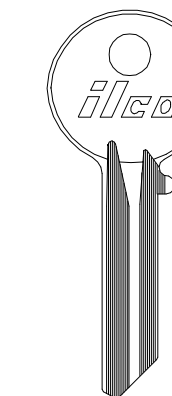

O997E **O997ER**
Y54 —

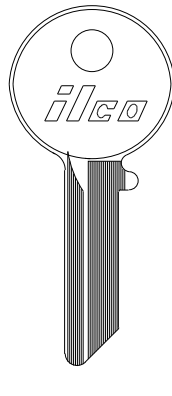

O997G
—

ILCO
EZ

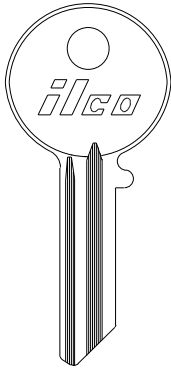
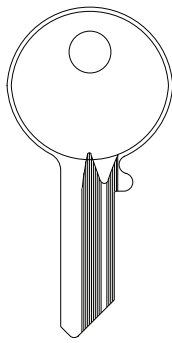
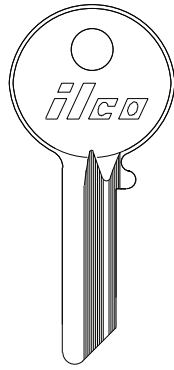
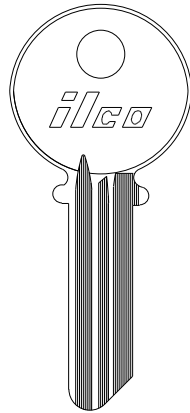
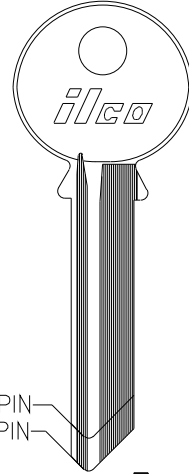
YALE

O997K
—

R997EB
—

997ER
—

998FD
—

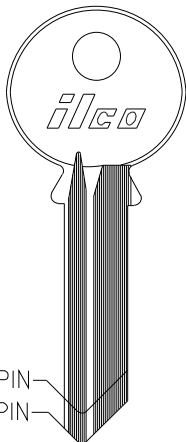
 6 PIN
7 PIN

998GST **A998GST**
— —

**ILCO
EZ**
**NORTH AMERICAN
CYLINDER**
YALE

sec 2 page 73

5 PIN	999LA —	999LB —	999LC —	999LD —	999LE —	999LF —	999LG —	999LH —	999LK —
6 PIN	998LA —	998LB —	998LC —	998LD —	998LE —	998LF —	998LG —	998LH —	998LK —

 5 PIN
6 PIN

998GL
—

6 PIN

YALE

NORTH AMERICAN
CYLINDER

5 PIN	999GA —	999GB —	999GC —	999GD —	999GE —	999GF —	999GG —	999GH —	999GK —
6 PIN	998GA Y78	998GB —	998GC —	998GD —	998GE —	998GF —	998GG —	998GH —	998GK —
7 PIN	S998GA —	S998GB —	S998GC —	— —	— —	— —	— —	— —	— —
7 PIN	D998GA —	D998GB —	D998GC —	D998GD —	D998GE —	D998GF —	D998GG —	D998GH —	D998GK —
7 1/2 PIN	H998GA —	H998GB —	H998GC —	H998GD —	H998GE —	H998GF —	H998GG —	H998GH —	H998GK —

ILCO
EZ

sec 2 page 74

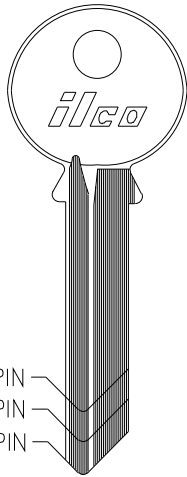

5 PIN
6 PIN
7 PIN

998G SERIES
999G SERIES
S998G SERIES

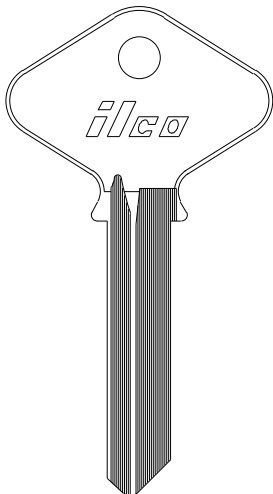

D998G SERIES



5 PIN

998S
—

6 PIN

998
Y4

7 PIN

998A
—

7 1/2 PIN

H998
—

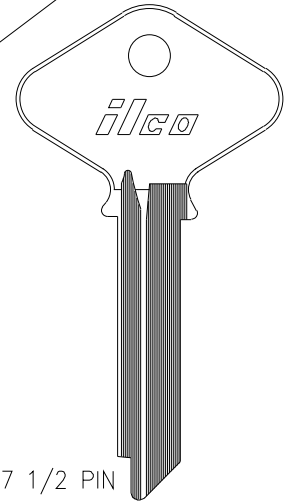

7 1/2 PIN

H998G SERIES

YALE

6 PIN	998SA —	998SB —	998SC —	998SD —	998SE —	998SF —	998SG —	998SH —	998SK —
7 1/2 PIN	H998SA —	H998SB —	H998SC —	H998SD —	H998SE —	H998SF —	H998SG —	H998SH —	H998SK —

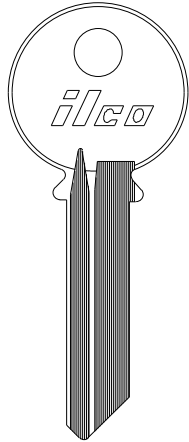

6 PIN

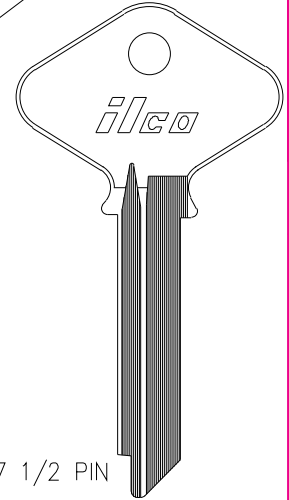

7 1/2 PIN

6 PIN		998SMK —
7 1/2 PIN		H998SMK —

6 PIN	998TA —	998TB —	998TC —	998TD —	998TE —	998TF —	998TG —	998TH —	998TK —
7 1/2 PIN	H998TA —	H998TB —	H998TC —	H998TD —	H998TE —	H998TF —	H998TG —	H998TH —	H998TK —

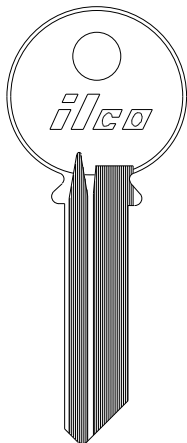

6 PIN

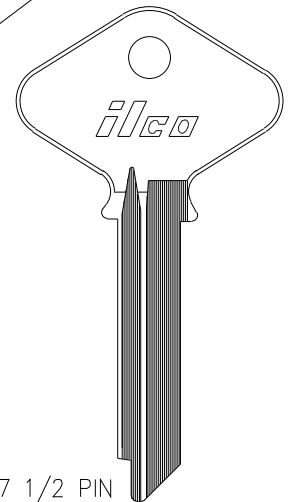

7 1/2 PIN

6 PIN		998TMK —
7 1/2 PIN		H998TMK —

YALE

NORTH AMERICAN
CYLINDER

sec 2 page 76

5 PIN	999VA —	999VB —	999VC —	998VD —	999VE —	— —	999VG —	999VH —	— —
6 PIN	998VA —	998VB —	998VC —	998VD —	998VE —	998VF —	998VG —	998VH —	998VK —
7 1/2 PIN	H998VA —	H998VB —	H998VC —	H998VD —	H998VE —	H998VF —	H998VG —	H998VH —	H998VK —

ILCO
EZ

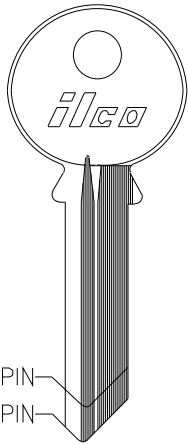

6 PIN	998R —
7 1/2 PIN	H998R —

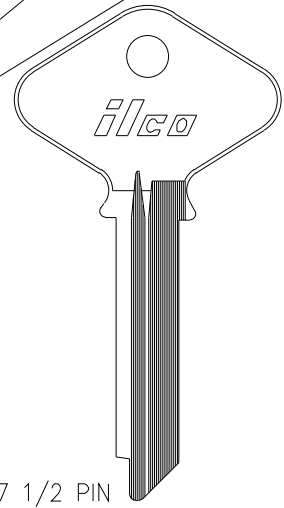

6 PIN	998YA —	998YB —	998YC —	998YD —	998YE —	998YF —	998YG —	998YH —	998YK —
7 1/2 PIN	H998YA —	H998YB —	H998YC —	H998YD —	H998YE —	H998YF —	H998YG —	H998YH —	H998YK —

ILCO
EZ

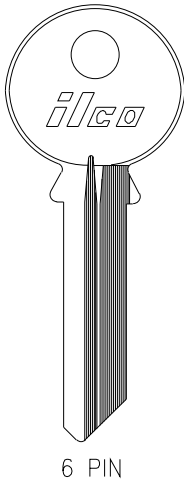

6 PIN	998YMK —
7 1/2 PIN	H998YMK —

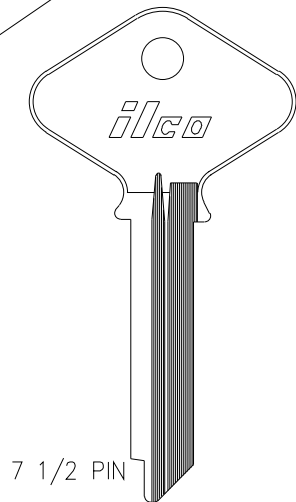

ILCO
EZ

YALE

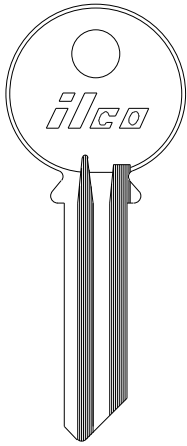

6 PIN

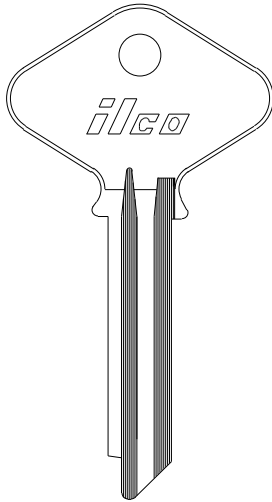

7 1/2 PIN

6 PIN 7 1/2 PIN



998ZA H998ZA



998ZB H998ZB



998ZC H998ZC



998ZG H998ZG

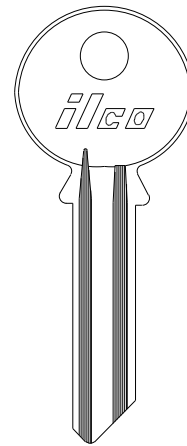

998PA



998PB



998PC



998PD



998PE



998PF



998PG



9098PH



998PK

ILCO
EZ

NORTH AMERICAN
CYLINDER

sec 2 page 77

YALE

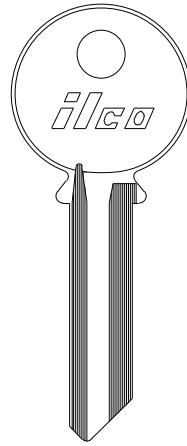

998SV

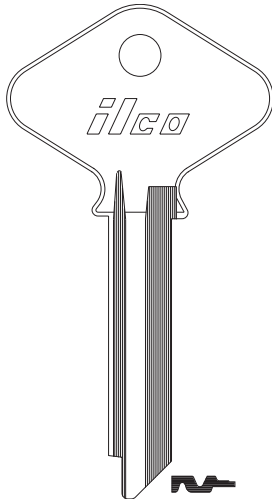

H998SV

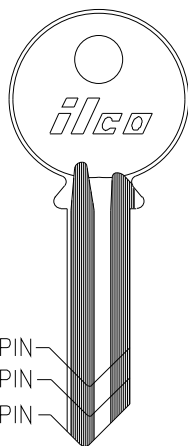

4 PIN
5 PIN
6 PIN

4 PIN
999B
Y220

5 PIN
999
Y1

6 PIN
999A
Y2

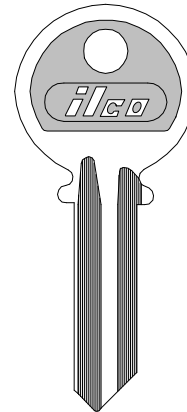

Y1-PC

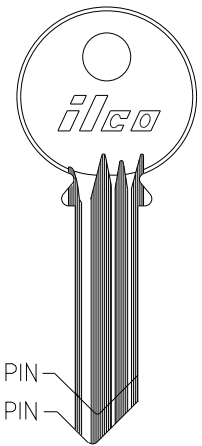

5 PIN
6 PIN

5 PIN 6 PIN
Y201 999CA

ILCO
EZ

YALE

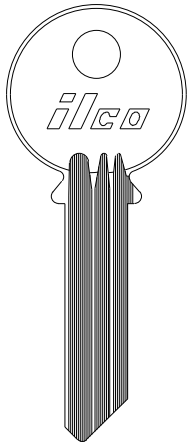

Y202

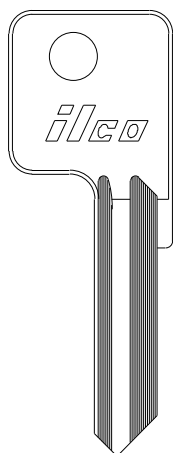

999N
Y1E

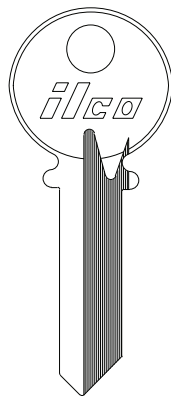

999R

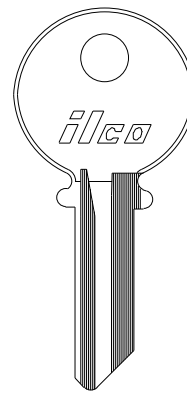

999T

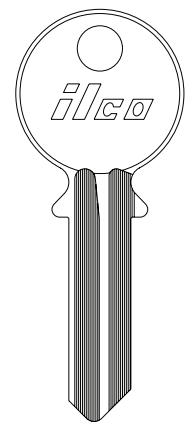

999U

ILCO
EZ

YALE

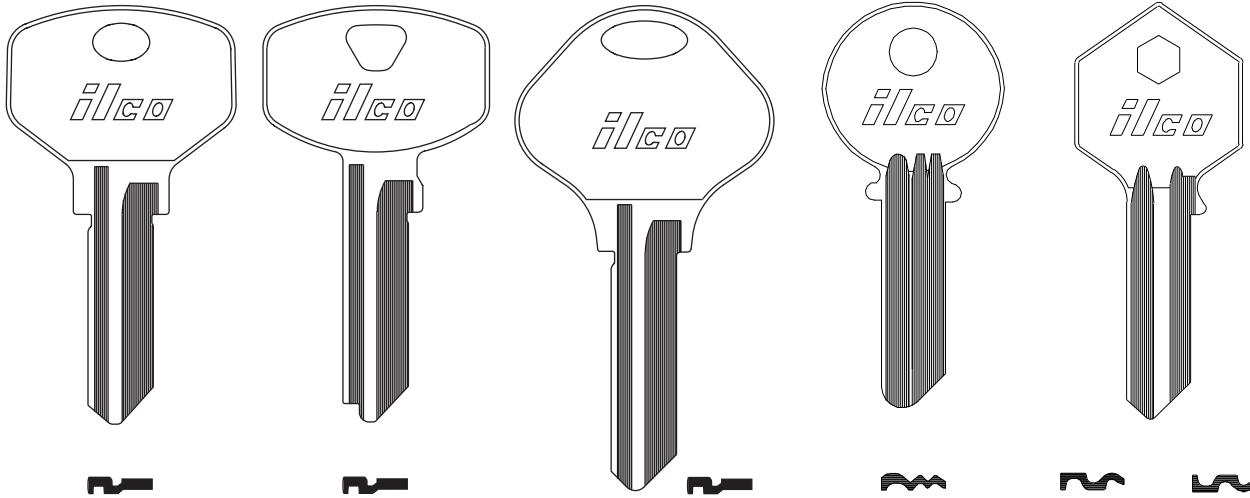

999K1
Y221

999K2
Y222

999K3
Y223

C999
Y3

H999 **H999R**
— —

ILCO
EZ

YALE

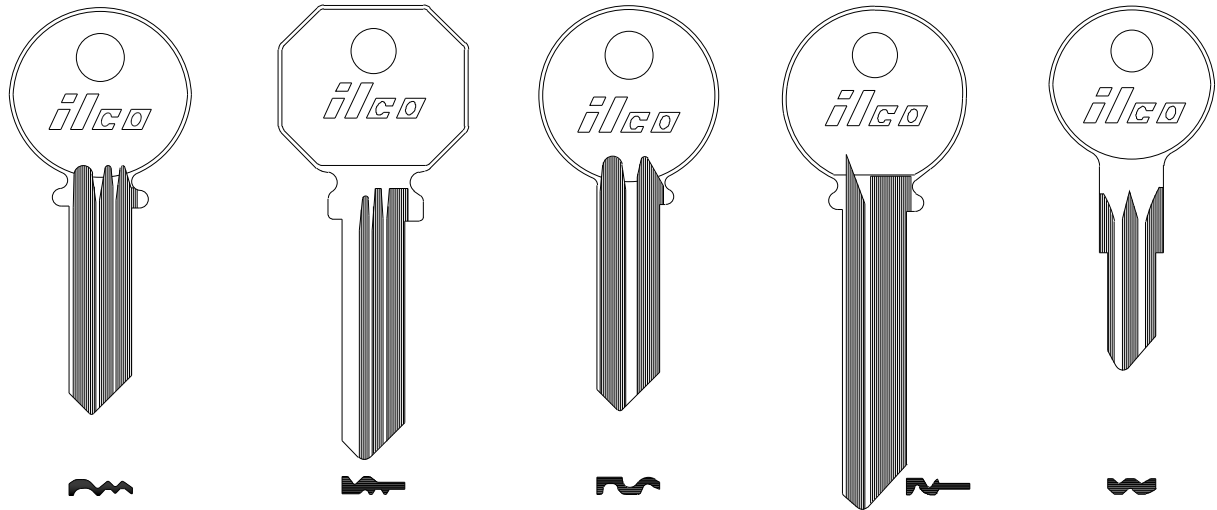

O999CR
—

HS999
—

X999
—

1015GM
—

1122D
—

ILCO
EZ

YALE

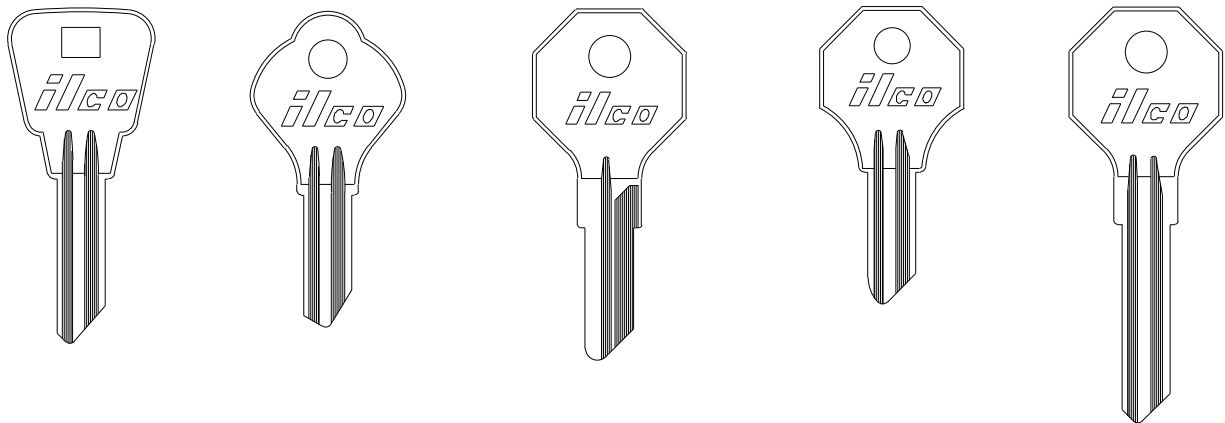

E1122A
—

F1122A **F1122AR**
— —

H1122AR **H1122A**
— —

H1122F **H1122FR**
Y9 —

H1122W
—

ILCO
EZ

YALE

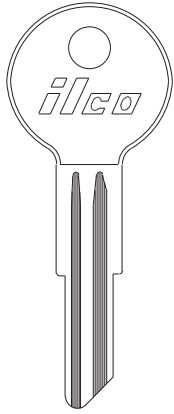

L1122AR
—

L1122B
—

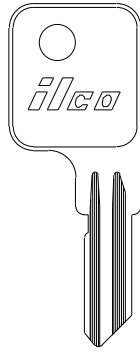

NO1122D
—

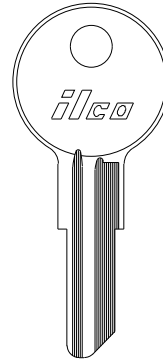

O1122A
Y12

O1122B
Y103

O1122BE
—

O1122AR
Y14

O1122BR
—

O1122BER
—

L1122A
Y101

O1122
Y11

O1122R
Y13

O1122C
—

ILCO
EZ

YALE



O1122NV
—



1132
—

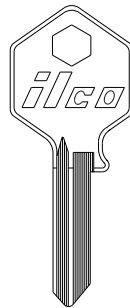

R1132
—

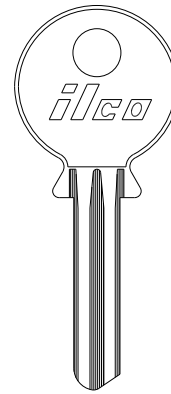

H1132
—

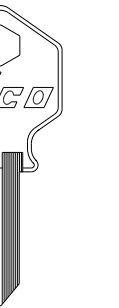

HR1132
—

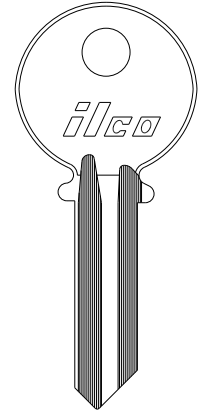

1143
—

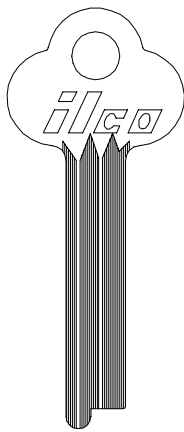

1554
—

ILCO
EZ

YALE

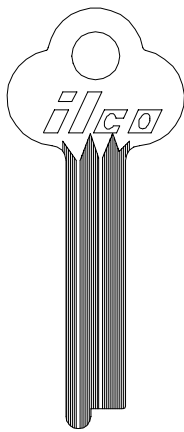

1587
—

ILCO
EZ

NORTH AMERICAN
CYLINDER